



Operation manual

Integral Process Thermostats and High-Temperature Thermostats

IN 130 T, IN 230 T, IN 230 TW, IN 530 T, IN 530 TW, IN 1030 T, IN 1330 TW, IN 1830 TW, IN 150 XT,
IN 250 XTW, IN 280 XT, IN 280 XTW, IN 550 XT, IN 550 XTW, IN 590 XTW, IN 750 XT, IN 950 XTW, IN 1590 XTW,
IN 1850 XTW, IN 2560 XTW, IN 2050 PW, IN 2560 PW, IN 4 XTW, IN 8 XTW

Manufacturer

LAUDA DR. R. WOBSE GMBH & CO. KG

Laudaplatz 1

97922 Lauda-Königshofen

Germany

Telephone: +49 (0)9343 503-0

E-mail: info@lauda.de

Internet: <https://www.lauda.de>

Translation of the original operation manual

Q4DA-E.13-006, 7, en_US 02/20/2023 © LAUDA 2019

Replaces issue V7R23, V6R9, V5R21, V5R20, V4R21, V3R38, V2R18/17, V1R100, V1R101

Table of contents

1	Safety.....	7
1.1	Safety information.....	7
1.2	Obligations of the operator.....	9
1.3	EMC requirements.....	10
1.4	Software versions.....	10
1.5	Observing additional operating instructions.....	11
1.6	Limits of the device.....	11
1.6.1	Application limits.....	11
1.6.2	Environmental and operating conditions.....	12
1.6.3	Time limits.....	12
1.7	Prohibition of modifications to the device.....	12
1.8	Materials.....	12
1.9	Fluorinated refrigerant.....	12
1.10	Requirements for the heat transfer liquid.....	12
1.11	Hose requirements.....	13
1.12	Personnel qualification.....	13
1.13	Personal protective equipment.....	13
1.14	Structure of warnings.....	14
1.15	Safety fittings on the device.....	14
1.15.1	Overtemperature protection.....	14
1.15.2	Low-level protection.....	15
1.15.3	Product safety label.....	15
1.15.4	Warning symbols for devices with NRTL approval.....	15
2	Unpacking.....	17
3	Device description.....	21
3.1	Overall view of Integral (small casing version).....	21
3.2	Overall view of Integral (medium casing version).....	22
3.3	Overall view of Integral (large casing version).....	23
3.4	Overall view of Integral (large casing version) with pressure overlay.....	24
3.5	Mains switch.....	25
3.6	Hydraulic circuit.....	25
3.7	Rating label.....	28
3.8	Interfaces.....	31
4	Before starting up.....	33
4.1	Install device.....	33
4.2	Hoses.....	34
4.3	Connecting an external application.....	36

4.4	LAUDA heat transfer liquids.....	39
4.5	Cooling water requirements.....	41
4.6	Connecting the cooling water.....	43
4.7	Configuring interfaces.....	44
4.7.1	Configure potential-free contact (alarm output).....	45
4.7.2	Interface potential-free contact.....	45
4.7.3	Configuring the Ethernet interface.....	46
4.7.4	Data transfer rate.....	52
4.7.5	Protocol of the interface.....	53
4.7.6	Read commands.....	53
4.7.7	Write commands.....	58
4.7.8	Error messages.....	61
5	Commissioning.....	62
5.1	Establishing a mains connection.....	62
5.2	Switching on the device for the first time.....	65
5.3	Operating the device with the operating unit.....	66
5.3.1	Home window, navigation and softkeys.....	66
5.3.2	Enter entry window and set temperature.....	68
5.3.3	Graph window.....	69
5.3.4	Operate the device using the Command Touch unit.....	70
5.4	Setting heat transfer liquid.....	70
5.5	Fill the device with heat transfer liquid.....	72
5.6	Degas heat transfer liquid (low boiling point expulsion).....	76
5.7	Setting the flow rate of the heat transfer liquid.....	78
6	Operation.....	81
6.1	General warning.....	81
6.2	Operating modes.....	83
6.3	Menu structure.....	85
6.4	Setting Tmax.....	88
6.5	Set the setpoint offset.....	89
6.6	Limiting heating and cooling.....	90
6.7	Dead-time correction.....	91
6.8	Dynamic heatlimiter.....	91
6.9	Cooling.....	92
6.10	Setting temperature limits Tih and Til.....	93
6.11	Lock and release operating buttons.....	93
6.12	Basic settings.....	94
6.13	Calibrating the temperature probe.....	97
6.14	Restore the factory setting.....	99

6.15	Viewing the Device status.....	100
6.16	Through-flow control of the internal heater.....	102
6.17	Programmer.....	103
6.17.1	Basic information.....	103
6.17.2	Set and process program.....	107
6.18	Set time, date, format and time zone.....	109
6.19	Self adaptation.....	110
6.20	Control parameters.....	111
6.20.1	Control basics.....	112
6.20.2	Overview of internal control parameters.....	114
6.20.3	Overview of external control parameters.....	115
6.20.4	Activate control variable.....	116
6.20.5	Change control parameters.....	117
6.20.6	Manual optimization of control parameters.....	117
6.21	Operator and viewer.....	120
6.22	Web server LAUDA Command.....	123
6.23	Cloud service LAUDA.LIVE.....	125
6.24	Safe Mode safety fittings.....	128
6.25	Importing and exporting data.....	131
6.25.1	Importing data.....	131
6.25.2	Exporting data.....	132
6.26	Operation with inert gas blanket.....	134
7	Operation of a high-temperature thermostat.....	135
8	Operating a device with pressure overlay.....	136
8.1	Warnings, safety instructions and further information.....	136
8.2	Menu structure of the pressure overlay.....	137
8.3	The system pressure in devices with pressure overlay.....	139
8.4	Setting the parameters for a pressure-stable application up to the maximum system pressure.....	139
8.5	Setting the parameters for a pressure-stable application.....	139
8.6	Filling and operating a device with pressure overlay.....	141
9	Maintenance.....	145
9.1	Warning notes for maintenance.....	145
9.2	Maintenance intervals.....	145
9.3	Cleaning the device.....	146
9.4	Cleaning the air-cooled condenser.....	146
9.5	Cleaning cooling water circuit.....	147
9.6	Checking the overtemperature protection.....	148
9.7	Checking the low-level protection.....	149
9.8	Check the heat transfer liquid.....	150

10	Faults.....	151
10.1	Alarms, errors and warnings.....	151
10.2	Alarms.....	151
10.3	Troubleshooting.....	153
11	Decommissioning.....	157
11.1	Information on decommissioning.....	157
11.2	Drain and clean the device.....	157
11.3	Draining the cooling water circuit.....	160
12	Disposal.....	161
12.1	Disposing of packaging.....	161
12.2	Disposing of refrigerant.....	161
12.3	Device disposal.....	161
12.4	Disposing of heat transfer liquid and liquids.....	162
13	Accessories.....	163
14	General.....	164
14.1	Copyright.....	164
14.2	Technical changes.....	164
14.3	Warranty conditions.....	164
14.4	License texts.....	164
14.5	Contact LAUDA.....	165
15	Technical data.....	166
15.1	General data.....	166
15.2	Heating output and power supply.....	171
15.3	Cooling output.....	173
15.4	Refrigerant and filling weight.....	179
15.5	Technical data of the high-temperature thermostats.....	181
15.6	Pump characteristics for Integral T.....	183
15.7	Pump characteristics for Integral XT.....	184
15.8	Pump characteristics for high-temperature thermostats.....	186
15.9	Declaration of Conformity and certificates.....	187
15.10	Modular mimic displays.....	191
15.11	Product Returns and Clearance Declaration.....	194
16	Index.....	195

1 Safety

1.1 Safety information



IMPORTANT

- Before using the device, please read the operating manual carefully.
- The information in this operating manual must therefore be kept at hand in the immediate vicinity of the device.
- Save the operating manual for later reference.
- This operating manual is part of the device. If the device is passed on, the operating manual must be kept with it.
- The operating manual is available on our homepage (<https://www.lauda.de>).



An overview of authorized personnel and the protective equipment can be found in ↪ Chapter 1.12 “Personnel qualification” on page 13 and ↪ Chapter 1.13 “Personal protective equipment” on page 13.



Refer to ↪ Chapter 1.14 “Structure of warnings” on page 14 for more information on the general structure of warnings.

The "Safe State" of the constant temperature equipment in the event of overtemperature, low level or failure is defined as:

- Heating off.
- The devices can only be operated as intended under the conditions specified in this operating manual. Any other mode of operation is considered to be unintended use and could compromise the protection provided by the device.
- You, the user, must check the functionality of the safety fittings of the device. The maintenance intervals must be complied with for this purpose.
- Transport the device carefully. The device must never be tilted or turned upside down.
- The device and the inside of the device could be damaged:
 - due to fall,
 - due to shock.
- The device may only be operated by trained personnel.
- Never put the device into operation if:
 - it is damaged,
 - it is leaky (for example, heat transfer liquid is escaping),
 - the mains cable and/or other cables are damaged.
- Do not install the device in areas with aggressive media.
- The installation surface must be sealed, level, non-slip and non-flammable.
- Keep the specified distance from other devices, objects or walls.
- Protect the device from dripping water or condensation.
- Do not store any liquids or flammable objects above the device.

- Do not handle flammable liquids in the immediate vicinity of the device.
- Do not place heavy parts on the device.
- The devices are intended for operation on grounded networks. Operation on IT networks, for example, is not permitted.
- Turn off the device and pull out the mains plug
 - for service and repair work,
 - when moving the device,
 - when installing or removing interface modules or accessories.
- Do not operate the device without heat transfer liquid.
- Only skilled personnel are permitted to perform service and repair work.
- Drain the device completely before moving it.
- Do not make any technical modifications to the device.
- The devices are not designed for use in medical applications in accordance with DIN EN 60601-1 and IEC 601-1!
- Only connect hydraulically closed applications to the device.
- In pressure-sensitive applications (e.g. glass apparatus) with a maximum permissible working pressure below the maximum pressure of the device pump, a pressure relief device must be installed to protect against gage pressure.
- Parts of the device (e.g. pump, drain connectors) can assume surface temperatures of over 70°C at higher operating temperatures (possible risk of burns).
- After a power failure or when the device is switched off, parts of the device may become hotter for a short time.
- Use suitable hoses.
- Use hose clamps to prevent the hose nozzle from slipping off the hoses.
- Check the hoses from time to time for possible material fatigue. If a hose breaks hot liquids may leak out, thus endangering people and materials.
- Hoses with heat transfer liquid and other hot parts may not come into contact with the mains cable.
- Do not operate the device if leaks have been detected. Ventilate the installation room immediately.
- The following actions may unintentionally restart the thermostat from standby,
 - previously activated timer operation,
 - 'Start' command over active interfaces on the device.
- Observe the permissible storage and operating temperatures of the device.
- The device may not be exposed to fire, otherwise there is danger of explosion.
- The device may only be operated with the casing mounted.
- If a hose and a collecting vessel are connected to the overflow pipe, the hose and container must be suitable for the heat transfer liquid and the maximum working temperature.
- The overflow may not be closed.
- Bring the heat transfer liquid to room temperature before draining.
- When changing to another heat transfer liquid, clean the device intensively and drain it completely. It is recommended to flush the device with the new heat transfer liquid.

- It is essential to avoid the penetration of secondary liquids into the device (e.g. via a defective heat exchanger provided by the customer).
- Observe all product safety labels/safety marks on the device.

Additional safety advice for water-cooled devices

- Use suitable cooling water to prevent corrosion in the cooling water circuit.
- The return hose of the water cooling system must be securely fixed in the outlet area to prevent uncontrolled slipping of the hose, even in the event of pressure surges.
- The return hose of the water cooling system must be fixed in the outlet area in such a way that hot cooling water cannot splash out.
- Avoid bending or squeezing the return hose of the water cooling system. Gage pressure can cause the cooling water hoses to rupture and hot cooling water to escape.
- In order to avoid damage caused by leakage of the cooling water system, it is recommended to install a leakage water detector with water shut-off.

Additional safety instructions for high-temperature thermostats with water cooling

- High-temperature thermostats with cooling water connection (type W) always require a cooling water supply, even if the devices are only used for heating.

1.2 Obligations of the operator

The national regulations for operation applicable in the country in which the system is installed must be complied with.

In particular, the application of statutory regulations concerning operational safety must be observed.

Note the installation conditions outlined in  Chapter 15.1 “General data” on page 166.

Operators within the EU must meet the applicable provisions of Regulation (EU) No. 517/2014 on fluorinated greenhouse gases. The regulation provides a complete overview, and includes:

- The general purpose of the regulation is to reduce emissions of fluorinated greenhouse gases.
- Regular tightness checks, depending on the quantity of CO₂ equivalent (see type plate and regulation; regular tightness checks may be necessary if the CO₂ equivalent exceeds 5 t).
- Having leakage inspections, maintenance, repairs, decommissioning or recovery work carried out by certified, authorized personnel (for example LAUDA Service).
- Keeping records of refrigerants added or recovered, including quantity and type. Records must be kept for a minimum of 5 years.

1.3 EMC requirements

Table 1: Classification in accordance with EMC requirements

Device	Immunity requirements	Emissions class	Customer power supply
Integral T Process thermostat Integral XT Process thermostat	Table 2 (Industrial) in accordance with EN 61326-1	Emissions Class B in accordance with CISPR 11	Only for EU Domestic connection value ≥ 100 A
Integral T Process thermostat Integral XT Process thermostat	Table 2 (Industrial) in accordance with EN 61326-1	Emissions Class B in accordance with CISPR 11	Rest of the world (outside EU) No limitation
Integral XT high-temperature thermostat	Table 2 (Industrial) in accordance with EN 61326-1	Emissions Class B in accordance with CISPR 11	No limitation

Instructions for Class A digital device, USA

"This equipment has been tested and found to comply with the limits for Class A digital device, pursuant to Part 15 of the FCC (Federal Communication Commission) Rules. These limits are designed to provide reasonable protection against harmful interference when the equipment is operated in a commercial environment. This equipment generates, uses, and can radiate radio frequency energy and, if not installed and used in accordance with the instruction manual, may cause harmful interference to radio communications. Operation of this equipment in a residential area is likely to cause harmful interference in which case the user will be required to correct the interference at his own expense."

Instructions for Class A digital device, Canada

"This Class A digital apparatus complies with Canadian ICES-003" (ICES = Interference Causing Equipment Standards).
« Cet appareil numérique de la classe A est conforme à la norme NMB-003 du Canada ».

1.4 Software versions

This operating manual is valid for devices with the following software versions or higher.

Software	Valid from version
Control system	1.46
Safety	1.24
Chilling	1.49
Heating	1.22
Pump	2.62
External temperature	1.46
Analog IO module	3.49

Software	Valid from version
RS 232/485 module	3.40
Web App	1.01

1.5 Observing additional operating instructions

Interface modules

Additional interface modules can be fitted to the device. Before installing and using interface modules, always read and observe the operating manual accompanying the relevant interface module.

1.6 Limits of the device

1.6.1 Application limits

Intended use

- The process thermostat and the high-temperature thermostat may only be used for the temperature control and circulation of flammable and non-flammable heat transfer liquids in a closed circuit. The heat transfer liquid is pumped through a hose to the external closed application and flows through a hose back into the thermostat. The heat transfer liquids and hoses to be used are listed in this operating manual.

Unintended use

The following are considered examples of unintended use:

- Medical applications
- Use in hazardous areas
- Use for controlling the temperature of foodstuffs
- Operation with a glass reactor without gage pressure protection
- Connection to a non-closed hydraulic circuit
- Outdoor installation

Reasonably foreseeable improper use

The following are considered cases of foreseeable misuse:

- Operating the device without heat transfer liquid
- Operating the device with an unsuitable heat transfer liquid
- Connecting hoses incorrectly
- Use of devices with cascade cooling together with a flow controller



Kryo 30 or glycol-water mixture must not be used in devices with cascade cooling (IN 280 XT(W), IN 590 XTW and IN 1590 XTW). Since the flow controllers (e.g. MID 80) only function with these heat transfer liquids, the flow controllers cannot be used together with the Integral IN devices mentioned above.

Type of energy supply

- Electrical energy (each device)
- Cooling water (required for water-cooled process thermostats and high-temperature thermostats)

Performance limits, operating values

- See the Technical Data chapter

1.6.2 Environmental and operating conditions

The device may only be used in the following areas:

- Production, quality assurance, research and development in an industrial environment
- Only used inside buildings
- Use up to a height of 2,000 m above sea level
- Ambient temperature from 5 °C to 40 °C
- Maximum relative humidity 80 % at an ambient temperature of 31 °C, relative humidity linearly decreasing to 50 % at 40 °C.
- Fluctuations of the mains voltage up to ± 10 % of the nominal voltage.
- Surge category II

1.6.3 Time limits

Service life	- The device is designed for 20,000 operating hours.
Maintenance intervals	- See  Chapter 9.2 "Maintenance intervals" on page 145

1.7 Prohibition of modifications to the device

Any technical modification of the device by the user is prohibited. Any damage resulting from unauthorized modification is not covered by customer service or the product warranty. Service work may only be performed by the LAUDA Service department or a service partner authorized by LAUDA.

1.8 Materials

All parts that come into contact with heat transfer liquid are manufactured from high-quality materials adapted to withstand the operating temperature. High-quality stainless steels, copper, brass and premium-quality heat-resistant plastics are used.

1.9 Fluorinated refrigerant

Refrigeration process thermostats are operated with fluorinated refrigerants. The designation and refrigerant charge are specified on the type plate.

1.10 Requirements for the heat transfer liquid

- Heat transfer liquids are used to control the temperature. LAUDA heat transfer liquids are recommended for the constant temperature equipment. LAUDA heat transfer liquids have been tested by the company LAUDA DR. R. WOBSEYER GMBH & CO. KG and approved for this device.
- The heat transfer liquids are suitable for a specific temperature range. This temperature range must correspond with the temperature range of your application.

- Hazards caused by high or low temperatures or fire may arise during operation if the heat transfer liquid exceeds or falls below certain temperatures or if the container ruptures causing a reaction with the heat transfer liquid.
- The safety data sheet of the heat transfer liquid specifies hazards and the corresponding safety measures required for handling the liquid. The safety data sheet of the heat transfer liquid must therefore be observed to ensure proper use of the device.
- If you wish to use your own heat transfer liquids, check to ensure that the fluids are compatible with the materials used.
- The heat transfer liquid must be provided with corrosion protection.

1.11 Hose requirements

The hoses for the external hydraulic circuit must be resistant to:

- the heat transfer liquid used
- the pressure in the hydraulic circuit
- the high and low working temperatures

1.12 Personnel qualification

Operating personnel

Operating personnel are personnel who have been instructed on how to use the device as intended in line with the information in the operating manual.

Specialized personnel

Certain activities on the device must be performed by specialized personnel. Specialized personnel are personnel whose education, knowledge, and experience qualify them to assess the function and risks associated with the device and its use.

1.13 Personal protective equipment



Protective gloves

Protective gloves must be worn for certain tasks. The protective gloves must comply with the standard DIN EN 374. The protective gloves must be chemically resistant.



Protective work clothing

Protective clothing must be worn for certain tasks. This protective clothing must meet the legal requirements for personal protective equipment. The protective clothing should be long-sleeved. Additionally safety shoes are required.



Safety glasses

Safety glasses must be worn for certain tasks. The safety glasses must comply with the standard DIN EN 166. The glasses must be tightly closed and equipped with side plates.

1.14 Structure of warnings

Warning signs	Type of danger
	Warning – danger zone.
Signal word	Meaning
DANGER!	This combination of symbol and signal word indicates an imminently dangerous situation that will result in death or serious injury if it is not avoided.
WARNING!	This combination of symbol and signal word indicates a potentially dangerous situation that can result in death or serious injury if it is not avoided.
CAUTION!	This combination of symbol and signal word indicates a possible dangerous situation that can result in minor injury if it is not avoided.
NOTICE!	This combination of symbol and signal word indicates a potentially dangerous situation that can result in material and environmental damage if it is not avoided.

1.15 Safety fittings on the device

1.15.1 Overtemperature protection

The overtemperature protection is a safety unit that prevents combustible heat transfer liquid from igniting due to high temperatures. All safety components on the device are shut down to prevent fire from posing a danger. An alarm signal also indicates that the overtemperature protection has been activated. The temperature at which the safety fitting is activated must be set in line with the heat transfer liquid used.

Repeat the checks of the overtemperature protection at regular intervals.



Further information ↪ Chapter 9.2 “Maintenance intervals” on page 145 and ↪ Chapter 9.6 “Checking the overtemperature protection” on page 148.

1.15.2 Low-level protection

The low-level protection is a safety unit that prevents damage to the device and prevents the hot heater from igniting combustible heat transfer liquid. If the fill level of heat transfer liquid level in the device falls below a specified level, a warning is issued initially. If the fill level continues to fall, an alarm is triggered. All safety components on the device are switched off as a result.

Repeat the checks of the low-level protection at regular intervals.



Further information ↪ Chapter 9.2 “Maintenance intervals” on page 145 and ↪ Chapter 9.7 “Checking the low-level protection” on page 149.

1.15.3 Product safety label

Hot



A “Hot surface” graphical symbol is affixed to the device. This symbol warns against hot surfaces on the device. These surfaces must not be touched during operation. These surfaces must be allowed to cool to room temperature before they can be touched during other operation phases such as servicing.

1.15.4 Warning symbols for devices with NRTL approval

Stickers on devices with NRTL approval



Operate the device only with the casing mounted

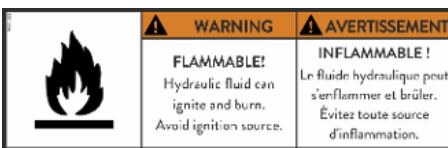

Flammable heat transfer liquid

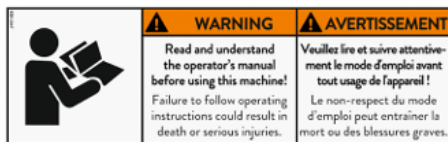

Read the operating manual



Wear protective equipment and protective clothing



Cold and hot surface temperatures

	WARNING	AVERTISSEMENT
	Crush hazard! Pulling the top may cause device to tip over. Be careful when moving the device. Ask an assistant to help moving the device.	Risque d'écrasement ! Tirer sur le dessus peut faire basculer l'appareil. Faites attention lorsque vous déplacez l'appareil. Veuillez demander une assistance pour vous aider à déplacer l'appareil.

Do not tilt the device

	WARNING	AVERTISSEMENT
	Falling load can cause severe injuries! Use the lifting points provided and use lifting eyes. Stand clear of load.	La chute de charge peut provoquer des blessures graves ! Utilisez les points de levage prévus à cet effet et utilisez des anneaux de levage. Tenez-vous à l'écart de la charge.

Never stand under suspended loads

	WARNING	AVERTISSEMENT
	Slip hazard! Wet surfaces may be slippery.	Risque de glissade ! Les surfaces humides peuvent être glissantes.

Slip hazard due to liquid on the floor

	WARNING	AVERTISSEMENT
	Crush hazard! Lock the castors when device is not transported.	Risque d'écrasement ! Bloquez les roues lorsque l'appareil n'est pas transporté.

Lock the castors

	WARNING	AVERTISSEMENT
	Hazardous voltage! Also if the main isolator is switched off, the yellow cable may still be live.	Tension dangereuse ! Même si l'isolateur principal est coupé, le câble jaune peut être sous tension.

The yellow cable is always live, even when the main switch is turned off!

	WARNING	AVERTISSEMENT
	Hazardous voltage! Contact may cause electrical shock and injuries. Disconnect power before servicing.	Tension dangereuse ! Le contact peut provoquer des chocs électriques et des blessures. Débranchez l'alimentation électrique avant toute intervention.

Disconnect the device from the mains before carrying out (service) work on the device.

400 V 50 Hz / 460 V 60 Hz 60 A 65 kA	NOTICE	AVIS
	For use on a solidly earthed grounded WYE source only! Use CU Cable 4 AWG!	À utiliser uniquement sur une source WYE solidement connectée à la terre ! Utiliser le câble CU 4 AWG !

Connect the correct cable and provide the appropriate mains power supply.

2 Unpacking

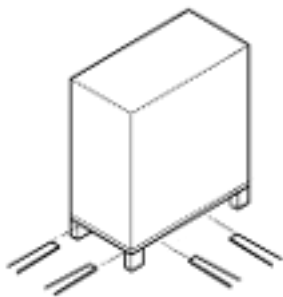

Fig. 1: Transport with forklift truck



DANGER!
Transport damage

Electric shock

- Closely inspect the device for transport damage prior to commissioning!
- Never operate a device that has sustained transport damage!

Personnel: Operating personnel

Check the device and accessories for completeness and transport damage immediately after delivery.



If the device or accessories are damaged contrary to expectations, immediately inform the shipping company so that a damage report can be compiled and the transport damage inspected. Also notify the LAUDA Service department immediately. You will find the contact information here ↪ Chapter 14.5 “Contact LAUDA” on page 165.



Keep the original packaging of your constant temperature equipment for subsequent transportation.

Unpack the device according to the following instructions.

1. **Fig. 1:** Cut and remove the strapping ①.
2. Lift the cover of the cardboard box ② and remove it.
3. Unscrew the bayonet locks ③ from the box. Turn them counterclockwise to perform this task.
4. Remove the box ④.
5. **Fig. 2:** Unscrew the screws ⑤ from the wooden cover. Turn them counterclockwise to perform this task. Remove the wooden cover ⑥.
6. **Fig. 3:** The device is bolted to the transport pallet with steel angles. Unscrew the screws ⑦ from the bottom of the device. Swivel the castors to the side so that they do not get caught on the angle when lifting the device.

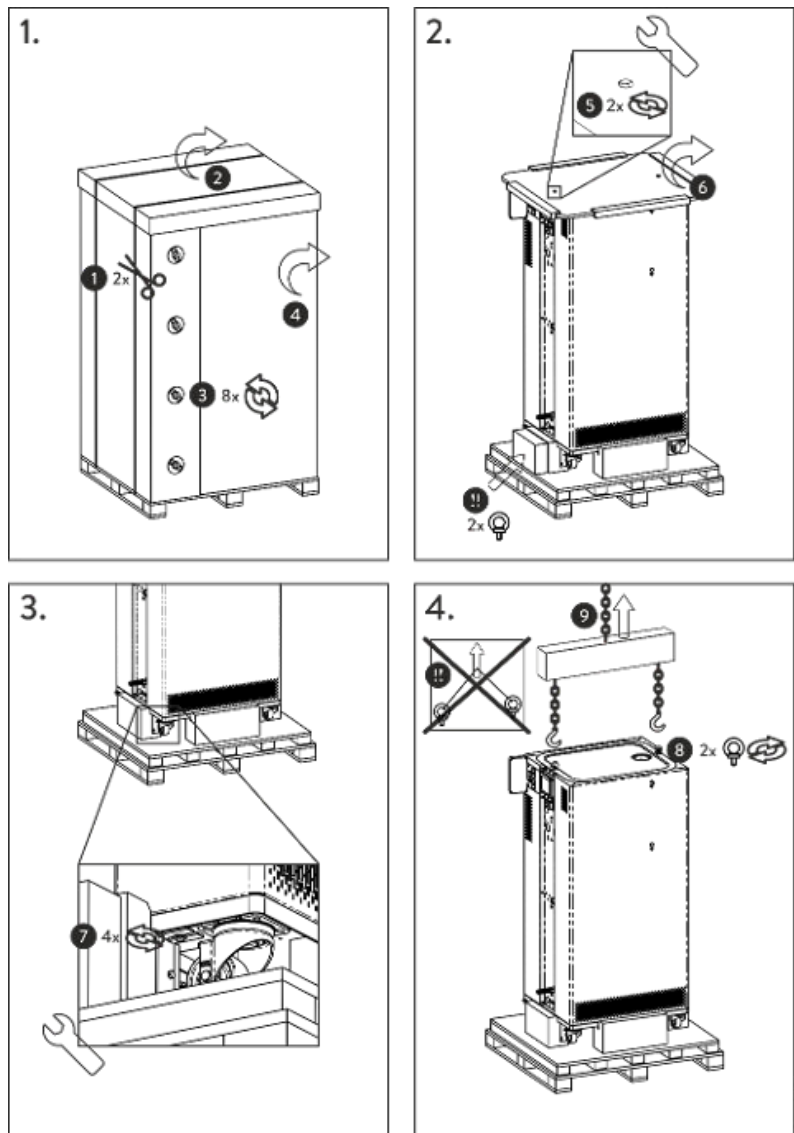

Fig. 2: Unpacking instructions

7. **Fig. 2:** Remove the ring bolts from the packaging.
8. **Fig. 4:** Screw the two ring bolts all the way into the thread connection Ⓢ (M10 or M16) on the top of the casing. Turn them clockwise to do so.



Fig. 3: Ring bolt (example)

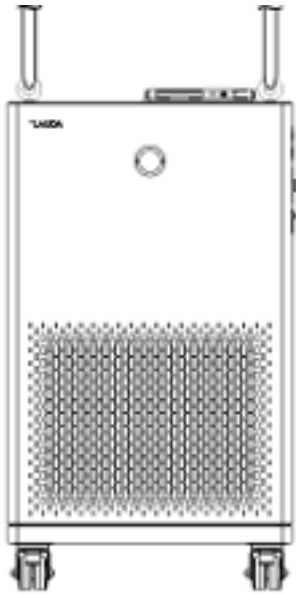

Fig. 4: Lift device

9. Use one permissible (textile) round sling, chain, steel cable or similar for each ring bolt. Attach the round slings securely to the crossbeam.
10. Align the round slings parallel to one another and at right angles to the top of the device. The crossbeam ⑨ must be parallel with the top of the device.



An inclined arrangement of the round slings is not permitted. Use a crossbeam.

11. Use a crane to lift the device off the transport pallet.

Table 2: Standard accessories Integral T

Device type	Designation	Quantity	Catalog number
All devices	Operating manual	1	Q4DA-E_13-006
All devices	Mains cable	1	---
IN 130 T, IN 230 T(W)	Ring bolt M10 x 17	2	DSS 044
IN 530 T(W), IN 1030 T, IN 1330 TW	Ring bolt M10 x 17 (higher load capacity)	2	DSS 085
IN 130 T to IN 530 TW	Hose fitting for pump connector	2	EOA 004
IN 1030 T to IN 1330 TW	Union nut for pump connector	2	EOV 197
IN 1030 T to IN 1330 TW	Hose nozzle for pump connector	2	HKA 168
All devices	Hose nozzle with union nut for drain nozzle	1	EOA 078
Water-cooled devices	Hose fitting for cooling water nozzle	2	EOA 001

Table 3: Standard accessories Integral XT

Device type	Designation	Quantity	Catalog number
All devices	Operating manual	1	Q4DA-E_13-006
All devices	Mains cable	1	---
IN 150 XT, IN 250 XTW	Ring bolt M10 x 17	2	DSS 044
IN 280 XT(W), IN 550 XT(W), IN 590 XTW, IN 750 XT, IN 950 XTW, IN 1590 XTW, IN 1850 XTW	Ring bolt M10 x 17 (higher load capacity)	2	DSS 085
IN 2050 PW, IN 2560 XTW, IN 2560 PW	Ring bolt M16 x 27	2	DSS 087
IN 2560 XTW, IN 2560 PW	Cable gland 26-35 mm	1	EKV 330
All devices	Hose nozzle with union nut for drain nozzle	1	EOA 078
Water-cooled devices	Hose fitting for cooling water nozzle	2	EOA 001

3 Device description

3.1 Overall view of Integral (small casing version)

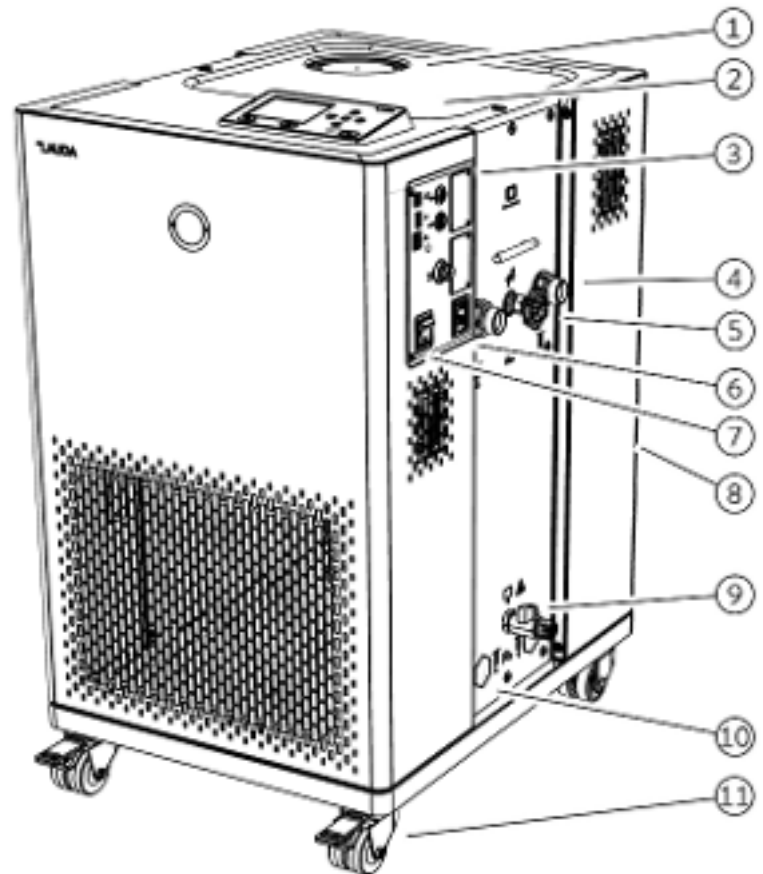

Fig. 5: View of Integral 230 T

- 1 Filler nozzle with cover
- 2 Operating unit
- 3 Interfaces and two slots for interface module
- 4 Pump connector
- 5 Adjusting wheel for bypass valve
- 6 Cold appliances built-in connector
- 7 Mains switch
- 8 Overflow pipe on the rear of the device (covered)
- 9 Drain tap for the hydraulic circuit
- 10 Additionally for water-cooled devices: connecting sleeves for cooling water
- 11 Four castors (front castors with parking brake)

3.2 Overall view of Integral (medium casing version)

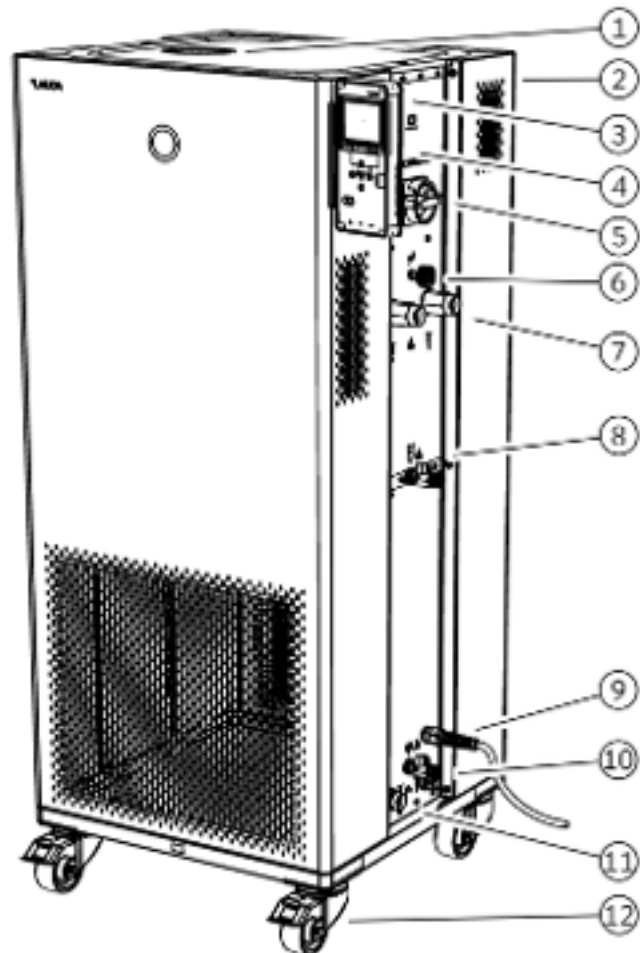

Fig. 6: View of Integral 950 XTW

- 1 Filler nozzle with cover
- 2 Overflow pipe on the rear of the device (covered)
- 3 Operating unit
- 4 Interfaces and two slots for interface module (covered)
- 5 Mains switch
- 6 Adjusting wheel for bypass valve
- 7 Pump connector
- 8 Drain tap for expansion vessel (from Integral 550 XT)
- 9 Power cable
- 10 Drain tap for the hydraulic circuit
- 11 Connecting sleeve for cooling water (only water-cooled devices)
- 12 Four castors (front castors with parking brake)

3.3 Overall view of Integral (large casing version)

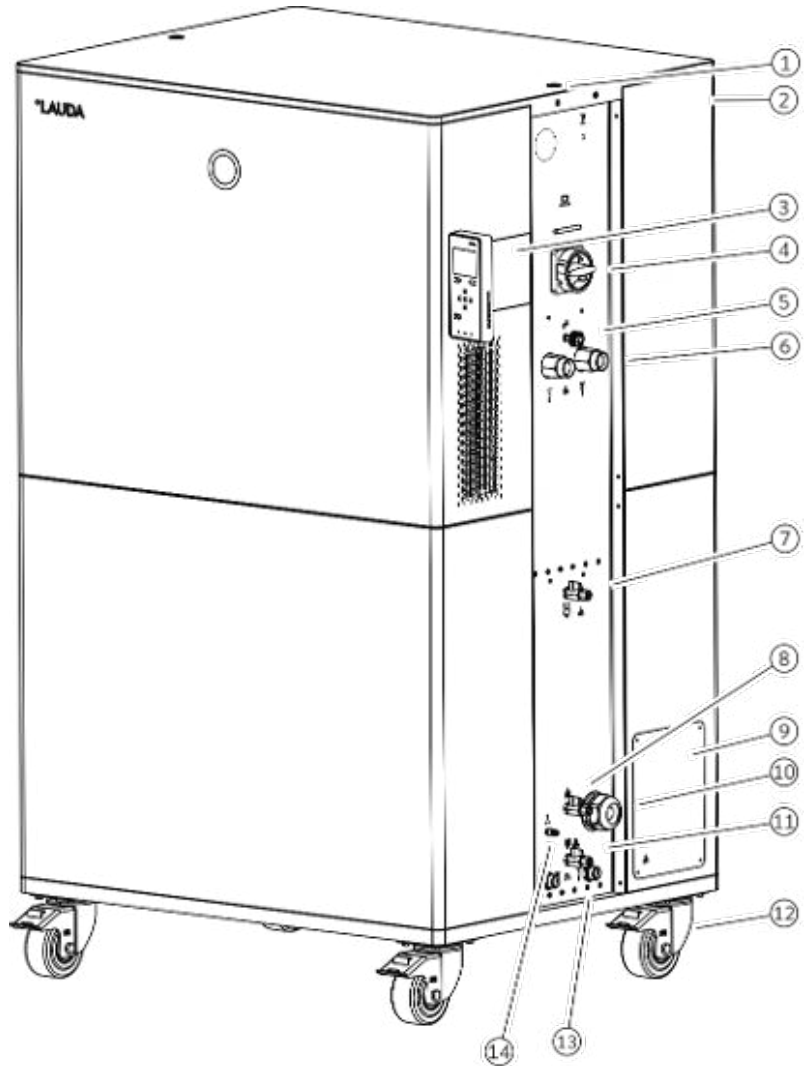

Fig. 7: View of Integral 2560 XTW

- 1 Thread connection for ring bolt
- 2 Overflow pipe on the rear of the device (covered)
- 3 Operating unit and two slots for interface modules
- 4 Mains switch
- 5 Adjusting wheel for bypass valve
- 6 Pump connector
- 7 Drain nozzle with drain tap for expansion vessel
- 8 Filling nozzle with non return valve
- 9 Connection box for mains cable
- 10 Cable gland for mains cable inlet
- 11 Drain nozzle with drain tap for hydraulic circuit
- 12 Four castors, each with parking brake
- 13 Connecting sleeve for cooling water
- 14 Connection for inert gas overlay

3.4 Overall view of Integral (large casing version) with pressure overlay

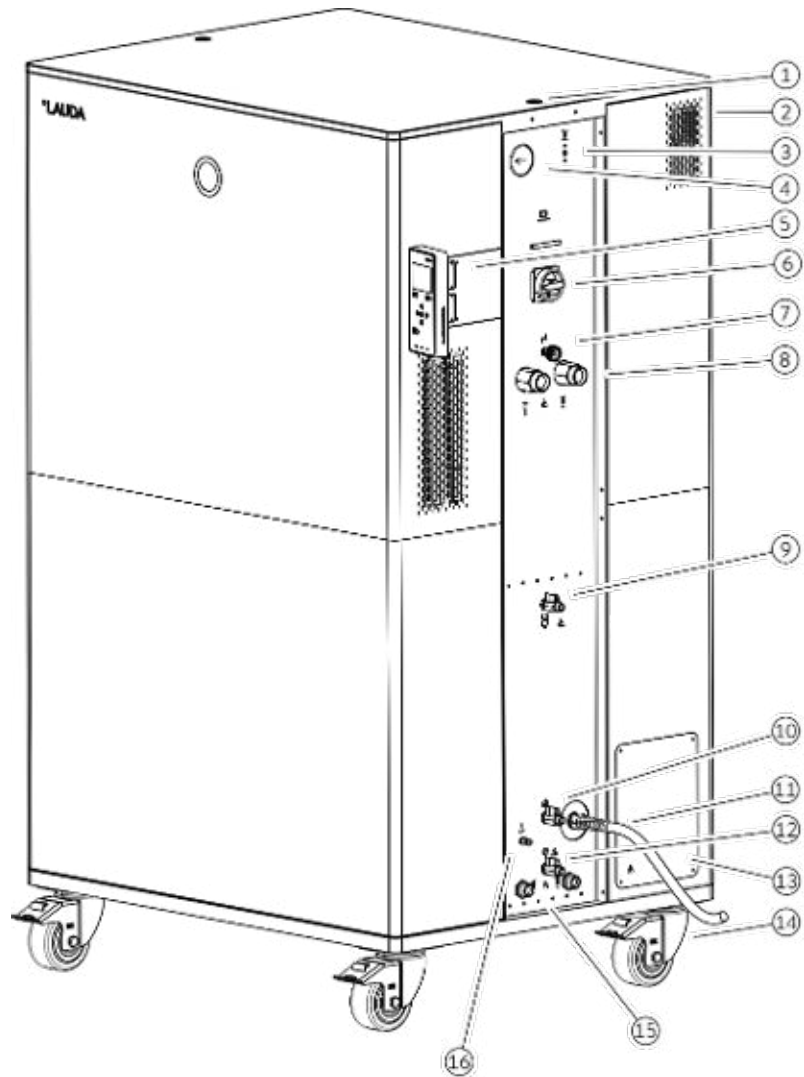

Fig. 8: View of Integral 2050 PW

- 1 Thread connection for ring bolt
- 2 Overflow pipe on the rear of the device (covered)
- 3 Pushbutton for releasing the compressed air
- 4 Hydraulic overpressure indicator (pressure gage)
- 5 Operating unit and two slots for interface modules
- 6 Mains switch
- 7 Adjusting wheel for bypass valve
- 8 Pump connector
- 9 Drain nozzle with drain tap for pressure vessel
- 10 Filling nozzle with non return valve
- 11 Mains cable
- 12 Drain nozzle with drain tap for hydraulic circuit
- 13 Connection box for mains cable (only for 2560 PW)
- 14 Four castors, each with parking brake
- 15 Connecting sleeve for cooling water
- 16 Connection for compressed air

3.5 Mains switch

The devices have a mains switch on the right side of the device. This is designed either as a toggle switch or as a rotary switch. Position [0] switches the device off, position [I] switches it on.



Mains switch on the single-phase device

The toggle switch is also designed as a safety switch. If the current is too high, the toggle switch trips and disconnects the device from the mains supply. The device can be used again by switching the toggle switch to position [I]. If the safety switch trips again, contact the LAUDA Service department.



Mains switch on the three-phase device

The automatic fuse may only be switched on by a qualified electrician!

The rotary switch is not designed as a safety switch. The three-phase device has a separate automatic fuse built in. If the automatic fuse trips, contact the LAUDA Service department.

3.6 Hydraulic circuit

Hydraulic circuit in Integral T

The Integral T process thermostat is a powerful device for the temperature control and circulation of heat transfer liquid with a very small active bath volume. A thermally largely inactive part of the bath boiler serves as an additional expansion volume.

Heating capacity and cooling capacity are matched to each other in order to achieve rapid temperature changes in both heating and cooling operation.

The powerful pressure pump in the device ensures the necessary flow. The pump always delivers the heat transfer liquid at maximum capacity. The components of the external hydraulic circuit must be designed for this maximum performance. In pressure-sensitive applications, the resulting pressure may have to be limited via the bypass.

In the event of a fault, large quantities of heat transfer liquid can flow back into the device from the external circuit. In order not to flood the appliance, the bath boiler has an overflow pipe.

In the heating-up area the pump works up to a kinematic viscosity of 200 mm²/s. 50 mm²/s should not be exceeded during regular operation. Optimum temperature control is under 30 mm²/s.

With the IN 1030 T, IN 1330 TW and IN 1830 TW devices, an additional pump is used to circulate the internal bath volume.

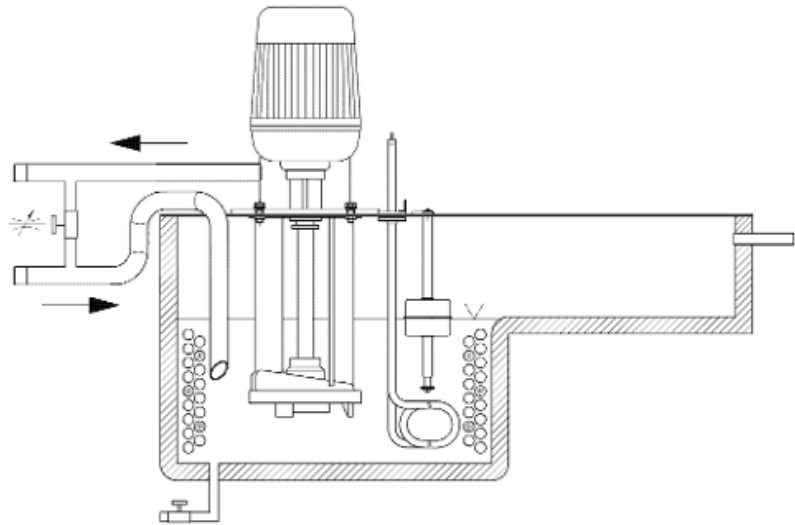

Fig. 9: Schematic of hydraulic circuit

The hydraulic circuit in the device consists of the following components:

- Bath boiler with expansion volume
- Level sensor
- Pump
- Bypass
- Heating
- Evaporator

Hydraulic circuit in Integral XT

The hydraulic circuit in the Integral XT consists of a piping system through which the heat transfer liquid flows under pressure.

All devices are equipped with an 8-stage, hermetically sealed (magnetically coupled) pump. The pump performance can thus be optimally adapted to the respective task: High pump pressure, if, for example, long hoses lead to the external consumer.

As an alternative to the 8 power stages, operation with pressure control is provided. The pressure control enables a very effective supply of pressure-sensitive glass reactors with maximum permissible pressurization.

In the event of a fault, large quantities of heat transfer liquid can flow back into the device from the external circuit. In order not to flood the appliance, the expansion vessel has an overflow pipe.

In the heating-up area the pump works up to a kinematic viscosity of $200 \text{ mm}^2/\text{s}$. $50 \text{ mm}^2/\text{s}$ should not be exceeded during regular operation. Optimum temperature control is under $30 \text{ mm}^2/\text{s}$.

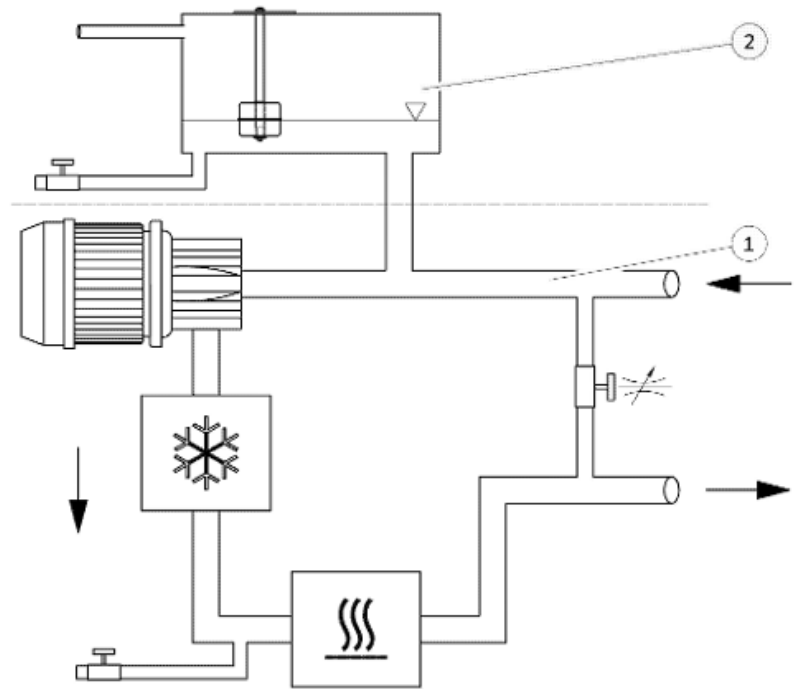

Fig. 10: Schematic of hydraulic circuit

- 1 Temperature-controlled
- 2 Not temperature-controlled

The hydraulic circuit in the device consists of the following components:

- Piping system
- Expansion vessel (not flowed through)
- Level sensor
- Pump
- Bypass
- Heating
- Evaporator

External hydraulic circuit

The external application is connected with hoses to the pump connectors of the device.

Only external applications with closed thermostatic circuits can be used on the Integral devices. Direct temperature control of open baths is not possible.

If the external temperature control volume exceeds the expansion volume in the Integral, a return flow of heat transfer liquid from higher-level consumers in the event of a fault or unintentional ventilation must be prevented with a reverse flow protection device.

The external hydraulic circuit consists of the following components:

- Hoses
- external application
- shut-off valves, if necessary

3.7 Rating label

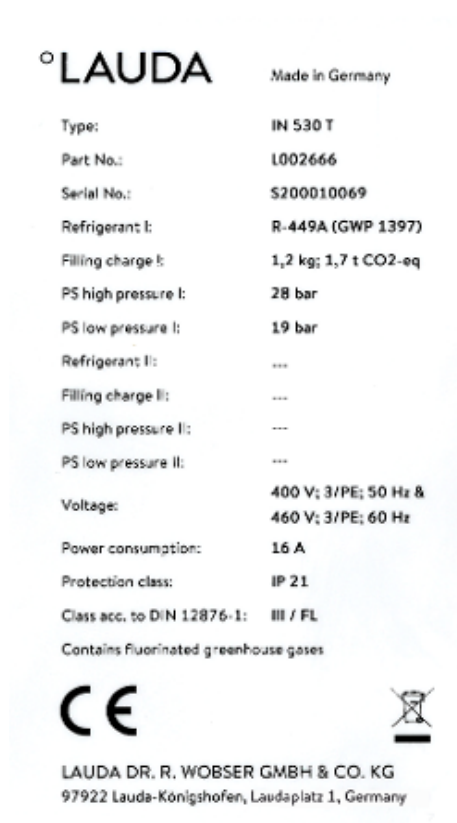

The serial number of a LAUDA device is made up as follows:

- the letter S,
- the year of manufacture (is shown with two digits),
- and a 7-digit number.

The figure shows an example of a rating label for a device without NRTL certification.

The specifications on the rating label are described in more detail in the following table. Certain specifications depend on the installed equipment.

Fig. 11: Rating label (example)

Specification	Description
Type:	Type of the device
Part No.:	Catalog number of the device
Serial No.:	Serial number of the device
Refrigerant I:	Refrigerant used in refrigeration circuit 1 of the appliance for cooling. The global warming potential (GWP) of the refrigerant is given in brackets.
Filling charge I:	Filling weight of the refrigerant and corresponding size of the CO ₂ equivalent in tonnes.
PS high pressure I:	Maximum permissible working pressure on the high-pressure side of the refrigeration circuit (compression, condensation)
PS low pressure I:	Maximum permissible working pressure on the low-pressure side of the refrigeration circuit (expansion, evaporation)
Refrigerant II:	Refrigerant used in refrigeration circuit 2 of the appliance for cooling. The global warming potential (GWP) of the refrigerant is given in brackets.
Filling charge II:	Filling weight of the refrigerant and corresponding size of the CO ₂ equivalent in the second stage.

Specification	Description
PS high pressure II:	Maximum permissible working pressure on the high-pressure side of the refrigeration circuit (compression, condensation)
PS low pressure II:	Maximum permissible working pressure on the low-pressure side of the refrigeration circuit (expansion, evaporation)
Voltage:	Permissible power supply
Power consumption:	Current consumption of the device
Protection class:	IP protection level of the device
Class acc. to DIN 12876-1:	According to DIN 12876-1, the device has the classification

The figure shows an example of a rating label for a device with NRTL certification.

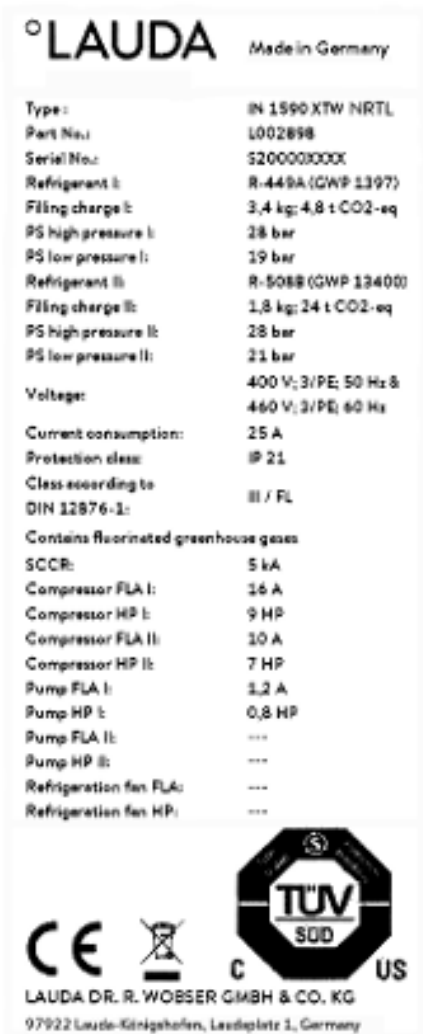

Fig. 12: Rating label (example)

Specification	Description
SCCR:	Indicates the short-circuit current according to NEC 110-10 or UL508A which the components and assemblies used in the machine can withstand
Compressor FLA I:	Current consumption of Compressor I under full load
Compressor HP I:	Power of Compressor I in horse power
Compressor FLA II:	Current consumption of Compressor II under full load
Compressor HP II:	Power of Compressor II in horse power
Pump FLA I:	Current consumption of Pump I under full load
Pump HP I:	Power of Pump I in horse power
Pump FLA II:	Current consumption of Pump II under full load

Specification	Description
Pump HP II:	Power of Pump II in horse power
Refrigeration fan FLA:	Current consumption of the fan under full load
Refrigeration fan HP:	Power of the fan in horse power

3.8 Interfaces

Standard interfaces



Fig. 13: Interfaces

- **USB interface device** (type B). Software updates (updater) are installed on the device via this interface (no process interface).
- The **USB interface host** (type A) allows the connection of a USB drive. This interface can be used, for example, for data import, data export and software updates (no process interface).
- The **Ethernet interface** enables the connection to a control station or a PC. This interface offers the customer the opportunity to control and monitor their temperature control processes via a LAUDA interface command set (process interface).
- The Command Touch remote control unit or the module box can be connected to the **LiBus interface** (marked with the label LiBus).
- The external Pt100 temperature probe is connected to the **Pt100 interface** (marked with the label Pt100).
- **Potential-free contact** (marked with label OUT), with built-in connector (after NAMUR NE 028) for program segment controlled signal transmission for freely selectable peripheral functions to be activated (e.g. alarm).

Accessories interface module

Different interface modules can be installed in the devices.

- The **analog module** (order no. LRZ 912) has a 6-pin socket with two inputs and two outputs. The inputs and outputs can be configured as a 0 – 20 mA, 4 – 20 mA or 0 – 10 V interface independently of one another. A voltage of 20 V applied to the socket supplies power to an external sensor with electronic evaluation unit.
- The **RS 232/485 interface module Advanced** (order no. LRZ 926) is available in a 9-pin SUB-D socket design Galvanically isolated by an optocoupler. When combined with the LAUDA interface command set, the module is compatible with the ECO, Variocool, Proline, Proline Kryomat, PRO, Integral XT and Integral T product lines. The RS 232 interface can be connected directly to the control stand / PC using a 1:1 contacted cable.
- The **Contact module Advanced** (order no. LRZ 927) is available in a plug connector design according to NAMUR NE28. This contact module is identical to LRZ 915 but only has 1 output and 1 input on 2 sockets. The coupling socket (order no. EQD 047) and the coupling connector (order no. EQS 048) have a 3-pin design.
- The **Contact module Advanced** (order no. LRZ 928) is available in a 15-pin SUB-D socket design. With 3 relay contact outputs (changeover contacts, maximum 30 V/0.2 A) and 3 binary inputs for control via external potential-free contacts.
- **Profibus module Advanced** (order no. LRZ 929). Profibus is a bus system used primarily in the chemical industry, which can connect a maximum of 256 devices at a high signal transmission rate.

- **EtherCAT module Advanced** (order no. LRZ 931) with M8 connection sockets. EtherCAT is an Ethernet-based field bus with master/slave functionality.
- **Pt100 LiBus module** (order no. LRZ 925) with a Lemo socket (label: Pt100) for an external Pt100 temperature probe. The LiBus socket (label: LiBus) serves to connect components via the LAUDA device bus.
- **External LiBus module box** (order no. LCZ 9727) with two additional module bays. The number of LiBus interfaces can be increased using the LiBus module box (LCZ 9727). Additional modules such as a solenoid valve for regulating the cooling water or a return protection can subsequently be connected.

Refer to the operating manual of the respective LAUDA interface module for further information on connecting and using these interfaces.

4 Before starting up

4.1 Install device



WARNING!

Rolling away or overturning of the device due to incorrect handling

Impact, crushing

- Do not tilt the device.
- Position the device on an even, non-slip surface with a sufficient load carrying capacity.
- Actuate the castor brake when setting up the device.
- Do not place heavy parts on the device.



WARNING!

Degradation of overflow or drain

Electric shock

- Overflow hose and drainage hose must each slope downward separately all the way into a collecting vessel.



WARNING!

Danger of overpressure from high ambient temperature

Injury, escape of refrigerant

- Note the permitted ambient temperature.



CAUTION!

Risk of heat transfer liquid escaping

Scalding, cold burns

- The temperature and media resistance of the hoses used for the device overflow must be suitable for the application.

Installation conditions:

- Irritant vapors may develop, depending on the heat transfer liquid and operating temperature used. Always ensure that the vapors are adequately extracted.
- Note the electromagnetic compatibility (EMC) requirements of the device ↪ Chapter 1.3 “EMC requirements” on page 10.
- Do not cover the ventilation openings of the device.
- Further conditions for installation apply to the devices. These are specified in the technical data ↪ Chapter 15.1 “General data” on page 166.

Personnel: Operating personnel

1. Place the device on a suitable level surface.



The devices can be moved. To do this, release the parking brakes on the castors by pushing the lever upwards.

2. Lock the castors of the device. To lock, press down the lever on the castor.

4.2 Hoses



CAUTION!
Risk of external hydraulic circuit bursting

Scalding, cold burns

- Use hoses with a greater compressive strength than the maximum possible pump pressure.



CAUTION!
Risk of heat transfer liquid escaping due to the use of unsuitable hoses

Scalding, cold burns

- The temperature and media resistance of the hoses must be suitable for the application.



CAUTION!
Contact with hot or cold hoses

Hot and cold burns

- Use insulated hoses for temperatures below 0 °C and above 70 °C.

Please note:

- The thread connections of the pump connectors or the thread connections of the screw cap and the seat of the nut must be moistened with lubricant.
- When laying the water cooling and heat transfer liquid hoses, make sure that the hoses cannot be kinked or crushed.

Approved metal hoses for Integral T



Metal hose made from stainless steel with screw caps

- Working pressure: maximum 10 bar
- Temperature range: -50 – 150 °C
- Application area: for heating and cooling applications with special insulation, for all LAUDA heat transfer liquids

Fig. 14: Corrugated metal hose with cold insulation

Hose type	Length in cm	Catalog number	Clear width in mm, connection thread	Maximum tightening torque in Nm
MTK 100	100	LZM 075	DN 20, G $\frac{3}{4}$ "	70
MTK 200	200	LZM 076	DN 20, G $\frac{3}{4}$ "	70

Approved metal hoses for Integral XT



Metal hose made from stainless steel with screw caps

- Working pressure: maximum 10 bar
- Temperature range: -100 – 350 °C
- Application area: for heating and cooling applications with special insulation, for all LAUDA heat transfer liquids

Fig. 15: Corrugated metal hose with cold insulation

Hose type	Length in cm	Catalog number	Clear width in mm, connection thread	Maximum tightening torque in Nm
M30X 100S	100	LZM 091	DN20, M30 x 1.5	70
M30X 200S	200	LZM 092	DN20, M30 x 1.5	70
M30X 300S	300	LZM 093	DN20, M30 x 1.5	70
M38X 100S	100	LZM 094	DN25, M38 x 1.5	130
M38X 200S	200	LZM 095	DN25, M38 x 1.5	130
M38X 300S	300	LZM 096	DN25, M38 x 1.5	130

Approved elastomer hoses (for water cooled devices)

Hose made from EPDM with textile insert

- the EPDM hose is suitable for the cooling water supply
- Temperature range: -40 – 120 °C
- Application area: for all LAUDA heat transfer liquids, except Ultra 350, Kryo 65 and mineral oils

Hose type	Catalog number	Clear width, Ø in mm x wall thickness	Maximum working pressure in bar
EPDM hose with textile insert, un-insulated	RKJ 103	½", Ø12 x 3.5	9
EPDM hose with textile insert, un-insulated	RKJ 104	¾", Ø19 x 3.5	9
EPDM hose with textile insert, un-insulated	RKJ 105	1", Ø25 x 3,5	6

4.3 Connecting an external application

DANGER!
 Risk of hot heat transfer liquid overflowing

	Fire
	<ul style="list-style-type: none"> ● A connecting hose with a collecting vessel must be attached to the overflow. ● The collecting vessel and connecting hose must be designed to withstand the maximum temperature of the heat transfer liquid. ● Avoid ignition sources in the vicinity of the collecting vessel.

CAUTION!
 Risk of external hydraulic circuit bursting from overpressure

	Scalding, cold burns
	<ul style="list-style-type: none"> ● When laying the hoses, make sure they cannot kink. ● Use safety valves in the hydraulic circuit.

CAUTION!
 Risk of heat transfer liquid escaping during operation due to open consuming unit

	Scalding, cold burns
	<ul style="list-style-type: none"> ● Always use hydraulically sealed consuming units.

The following information is only relevant for the Integral T device:



CAUTION!
Risk of external consumer bursting

Scalding, cold burns

- Adjust the pump pressure with the bypass.



CAUTION!
Risk of heat transfer liquid escaping from consuming unit in an elevated location

Electric shock

- If the external consuming unit is positioned above the device, heat transfer liquid may escape from the device when the pump stops. Therefore use the return protection available as an accessory in the external hydraulic circuit.

The following information is only relevant for the Integral XT device:



CAUTION!
Risk of external consuming unit bursting

Scalding, cold burns

- If the external consuming unit is located in a lower position and is sensitive to pressure, also take into account the additional pressure resulting from the difference in height between the consuming unit and the device.

Please note:

- Only connect hydraulically closed applications to the device!
- Use the shortest possible hoses with the largest possible diameter in the external circuit.
If the diameter of the hose is too small, there will be a temperature gradient between the device and the external application due to the low flow rate. In this case, increase the outflow temperature or pump level accordingly.
- Secure the hoses to the hose nozzles using hose clips.
- If using a pressure-sensitive application (such as a glass reactor), use a pressure relief device.
- Open any shut-off valves in the external application. Only switch on the device when flow is possible through the external application.
- Depending on the type of application, a vent valve can significantly simplify the aeration process. The vent valve must be located at the highest point of the circuit (Fig. 16).
- Reactors for steam heating are not suitable as external applications, as they usually have a non-flow-through area in which gas cushions can form.
- If external control is used, a Pt100 sensor must be installed in the external application or the external temperature signal is transmitted via an interface module.

- If the external application is in a higher position, the application may run empty if the pump is switched off and air enters the thermostatic circuit (e.g. due to an incompletely closed or defective vent valve). This can cause the heat transfer liquid in the process thermostat to overflow.
- Install a dirt trap if the circuit in the application is not free of dirt.

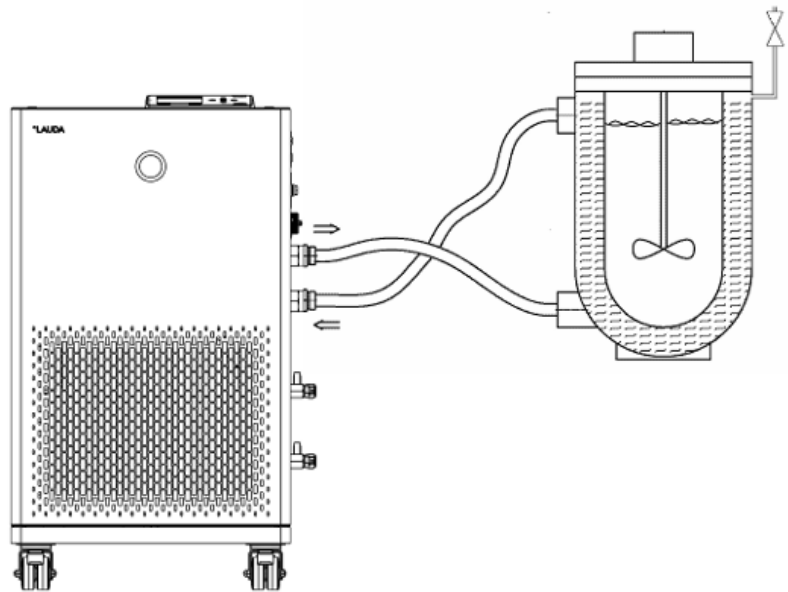

Fig. 16: Connection diagram with vent valve

The external application must be connected according to the sketch (Fig. 16) so that gas/vapor bubbles can be removed from the system and undisturbed operation is possible. The outflow of the pump must be connected to the lower connection of the application. The return line to the pump connector must be connected to the top connection of the application. The application is thus flowed through from bottom to top.

Mounting instructions for connecting an application

Hose nozzle:

- Push the hose onto the hose nozzle. Secure the hoses against slipping using hose clips or similar.

Ball bush and hose nozzle:

- The sealing surfaces of the cone and ball bush/hose nozzle may not be damaged (falling onto hard ground or similar).
- Carefully remove dirt from the sealing surfaces (cone and ball bush / hose nozzle) before assembly.
- Place the ball bush/hose nozzle vertically on the cone (support the hose when tightening).
- The ball bush / hose nozzle may not rotate when tightening the union nut (if necessary apply some grease or oil between the ball bush / hose nozzle and union nut).
- Tighten the union nut only moderately with the open-end wrench and hold it against the connecting sleeve with a second open-end wrench.

4.4 LAUDA heat transfer liquids

 DANGER! Use of unsuitable heat transfer liquid	
Fire	<ul style="list-style-type: none"> Select a heat transfer liquid with a temperature range suitable for the application.

Please note:

- If the heat transfer liquid reaches the lower limit of the temperature range, the temperature control properties can be expected to deteriorate as a result of the increase in viscosity. Therefore, only fully utilize this temperature range when absolutely necessary.
- Never use contaminated heat transfer liquid. Contamination in the pump housing can cause the pump to seize and the device to shut down.
- Observe the safety data sheets for the various heat transfer liquids. If required, you can download the safety data sheets from our homepage. Open the LAUDA homepage, tap → *Services* → *Download center*. In the Download center, chose the [Safety data sheet] option in the [Document type] drop-down list. A list of safety data sheets in PDF format in different languages is displayed. Tap the relevant safety data sheet. The download starts and the PDF file is downloaded.

Please note:

- When using **Kryo 30**:
The water content decreases during longer periods of operation at higher temperatures and the mixture becomes flammable (flash point 119 °C). Check the mixing ratio using a hydrometer.
- When using **Aqua 90**:
Evaporation losses occur at higher temperatures.
- When using **Ultra 350** and **Kryo 65**:
EPDM hoses are not suitable for Ultra 350 and Kryo 65.
- When using **mineral oils**:
EPDM hoses are not suitable for mineral oils.
- When using **silicone oils**:
Silicone hoses are not suitable for silicone oils.
- When operating the **IN 2560 XTW/PW**:
When operating with a glycol-water mixture, you must either select the Kryo 30 heat transfer liquid on the constant temperature equipment, or store actual viscosity values for your user-specific heat transfer liquid in the constant temperature equipment → “The entered values of the heat transfer liquid are:” on page 71. Otherwise the function of the device may be affected at outflow temperatures below -20 °C.

Heat transfer liquid, water

- The proportion of alkaline earth ions in the water must be between 0.71 mmol/L and 1.42 mmol/L (equivalent of 4.0 and 8.0 °dH). Harder water leaves limescale deposits in the device.
- The pH value of the water must be between 6.0 and 8.5.
- Distilled, deionized or fully desalinated (FD) water is unsuitable due to its reactivity. High-purity water and distillates are suitable as a heat transfer liquid after 0.1 g of soda (Na₂CO₃, sodium carbonate) is added for every liter of water.
- Sea water is unsuitable due to its corrosive properties.
- Avoid chlorine content in the water at all costs. Do not add chlorine to the water. Cleaning agents and disinfectants, for example, contain chlorine.
- The water must be free of impurities. Water with iron content is unsuitable due to rust formation and untreated river water is unsuitable due to algae growth.
- The addition of ammonia is not permitted.

Table 4: Permissible heat transfer liquids for Integral T

Designation	Chemical characterization	Working temperature range in °C	Viscosity (kin) in mm ² /s at 20 °C	Viscosity (kin) in mm ² /s at temperature	Flash point in °C
Kryo 51	Silicone oil	-50 – 120	5	34 at -50 °C	120
Kryo 30	Monoethylene glycol/water mixture	-30 – 90	4	50 at -25 °C	---
Kryo 20	Silicone oil	-20 – 170	11	28 at -20 °C	170
Aqua 90 ¹	Decalcified water	5 – 90	1	---	---
Ultra 350	Aromatic hydrocarbon	30 – 200	48	16 at 40 °C	212
Ultra 301 ²	Mineral oil	40 – 230	76.5	35.4 at 40 °C	245



Please note:

¹ Aqua 90 or water may only be used in the Integral IN 130 T and IN 230 T(W) devices.

² Recommendation: Overlay with nitrogen at 150 °C and above

Table 5: Permissible heat transfer liquids for Integral IN XT (closed system)

Designation	Chemical characterization	Working temperature range in °C	Viscosity (kin) in mm ² /s at 20 °C	Viscosity (kin) in mm ² /s at temperature	Flash point in °C
Kryo 95	Silicone oil	-95 – 160	1.6	20 at -80 °C	64
Kryo 70 A	Silicone oil	-70 – 220	5.3	44 at -60 °C	125
Kryo 70	Silicone oil	-70 – 220	5	42 at -60 °C	121
Kryo 65	Hydrocarbon	-65 – 140	1.7	10 at -40 °C	62
Kryo 30 ¹	Monoethylene glycol/water mixture	-30 – 90	4	50 at -25 °C	---

Designation	Chemical characterization	Working temperature range in °C	Viscosity (kin) in mm ² /s at 20 °C	Viscosity (kin) in mm ² /s at temperature	Flash point in °C
Ultra 350 ²	Aromatic hydrocarbon	30 – 350	48	16 at 40 °C	212
Ultra 301	Mineral oil	40 – 300	76.5	35.4 at 40 °C	245

Please note:

- ² Use Ultra 350 for the Integral high-temperature thermostats.



¹ Do not use Kryo 30, glycol-water mixtures or concentrated brine in devices with cascade cooling. This applies to the Integral IN 280 XT(W), IN 590 XTW and IN 1590 XTW device types.



Water may NOT be used with any Integral IT XT units over the entire working temperature range.

Table 6: Heat transfer liquid order numbers

Designation	Container size		
	Catalog number		
	5 L	10 L	20 L
Kryo 95	LZB 130	LZB 230	LZB 330
Kryo 70 A	LZB 131	LZB 231	LZB 331
Kryo 70	LZB 127	LZB 227	LZB 327
Kryo 65	LZB 118	LZB 218	LZB 318
Kryo 51	LZB 121	LZB 221	LZB 321
Kryo 30	LZB 109	LZB 209	LZB 309
Kryo 20	LZB 116	LZB 216	LZB 316
Aqua 90	LZB 120	LZB 220	LZB 320
Ultra 350	LZB 107	---	---
Ultra 301	LZB 153	LZB 253	LZB 353

4.5 Cooling water requirements

This section is relevant for:

- Water-cooled devices

! NOTICE!
Risk of cooling circuit leaking due to corrosion

Device damage

- Do not use corrosive cooling water.

Requirements

Cooling water is subject to specific purity requirements. A suitable procedure must be employed to purify the cooling water in line with the contamination in the water and maintain the water quality. Unsuitable cooling water may cause the condenser and the entire cooling water circuit to become blocked or damaged, or start to leak. The entire cooling circuit and cooling water circuit may sustain extensive consequential damage as a result.

- Free chlorine consisting of disinfectant, for example, and water containing chloride will cause pitting corrosion in the cooling water circuit.
- Distilled, deionized and demineralized water are unsuitable due to their reactivity and will cause corrosion in the cooling water circuit.
- Sea water is unsuitable due to its corrosive properties and will cause corrosion in the cooling water circuit.
- Iron particles and water containing iron will cause corrosion in the cooling water circuit.
- Hard water is unsuitable for cooling due to the high lime content and will lead to calcification of the cooling water circuit.
- Cooling water containing suspended matter is unsuitable.
- Untreated, unpurified water such as river water or cooling tower water is unsuitable due to its microbiological content (bacteria), which can settle inside the cooling water circuit.

Suitable cooling water quality

Data	Value	Unit
pH value	7.5 – 9.0	---
Hydrocarbonate [HCO ₃ ⁻]	70 – 300	mg/L
Chloride	< 50	mg/L
Sulfate [SO ₄ ²⁻]	< 70	mg/L
Ratio hydrogen carbonate [HCO ₃ ⁻] / sulfate [SO ₄ ²⁻]	> 1	---
Total water hardness	4.0 – 8.5	°dH
Electrical conductivity	30 – 500	µS/cm
Sulfite (SO ₃ ²⁻)	< 1	mg/L
Free chlorine gas (Cl ₂)	< 0.5	mg/L
Nitrate (NO ₃ ⁻)	< 100	mg/L
Ammonia (NH ₃)	Not permitted	---

Data	Value	Unit
Iron (Fe), dissolved	< 0.2	mg/L
Manganese (Mn), dissolved	< 0.05	mg/L
Aluminum (Al), dissolved	< 0.2	mg/L
Free aggressive carbon dioxide (CO ₂)	Not permitted	---
Hydrogen sulfide (H ₂ S)	Not permitted	---
Algae growth	Not permitted	---
Suspended matter	Not permitted	---

4.6 Connecting the cooling water

This section is relevant for:

- Water-cooled devices

All water-cooled devices are equipped with the following cooling water connection:

- Exterior thread (male) G ¾ inch

Table 7: Cooling water data

Specification	Value
Maximum cooling water pressure	10 bar
Cooling water temperature	15°C recommended; 10 to 30°C permitted (in upper temperature range with reduced cooling output)
Cooling water pressure difference Fig. 91	3 bar recommended; 0.8 to 5 (10) bar permitted (in lower temperature range with reduced cooling output)

Settings in the cooling water circuit menu

In the cooling water circuit menu, you have the choice of selecting either the [Cooling water circuit] (factory setting) or the [Mains water tap water] setting.

Selecting the [Mains water tap water] setting reduces the water consumption during regular operation. As a result, the outlet temperature of the cooling water is significantly higher due to the lower water throughput. This setting is not recommended for cooling water circuits.

Please note:

- Connect the cooling water inlet and outlet according to the labeling on the device. The inlet and outlet of the cooling water supply may not be interchanged.
- The hoses used for the cooling water circuit must be suitable for the temperature range specified. Also observe the permitted hose diameter.

- Secure the hose nozzles or the coupling connectors to the hoses using hose clips.
- Secure the water cooling return hose in the outlet area to prevent the hose from jerking suddenly, even when pressure surges occur.
Secure the water cooling return hose in the outlet area in such a way that hot cooling water cannot spray out.
- Avoid kinking or crushing the hoses.
- We recommend using a leakage water detector with water shut-off function to prevent leakages from causing damage in the cooling water system.
- Only use cooling water that meets the quality requirements.
- If the condenser leaks, there is a danger that refrigerating machine oil or combustible/non-combustible refrigerant from the device's refrigerant circuit will mix with the cooling water. Observe the legal requirements and provisions of the water supply company applicable at the operation site.

4.7 Configuring interfaces



WARNING!
Touching pieces charged with voltage when installing the modules

Electric shock

- Disconnect the device before installing modules.

Personnel: ■ Specialized personnel



Equipment connected to the low-voltage inputs and outputs must be safely insulated against dangerous contact voltages as per DIN EN 61140, for example, using double or reinforced insulation as per DIN EN 60730-1 or DIN 60950-1.



Refer to the separate operating manual accompanying the interface modules for further information on installing and operating these interface modules. Each respective operating manual must be observed in order to use the module as intended.

4.7.1 Configure potential-free contact (alarm output)

In the *Alarm output* menu, an option is always selected. The selected option is marked with a check mark. You can combine the other options.

A fault in the device can be an alarm or an error.

Table 8: Possible options

Options	Description
<i>Fault</i>	Signal transmission (e.g. for reverse flow protection, pilot lamp)
<i>Safe Mode</i>	Activation of Safe Mode (Safe Mode must be switched on beforehand in the device menu)
<i>Standby</i>	Switch device into standby

Personnel: Operating personnel

1. Switch to the main menu.
2. Select the *Setup* → *Basic setup* → *Alarm output* menu item.
3. The following options are available:
 - Fault*
 - Safe Mode*
 - Standby*
4. Press the Enter key to confirm your selection.

4.7.2 Interface potential-free contact

- The contacts may be loaded with a maximum voltage of 30 V direct current (DC) and a maximum current of 0.2 A.

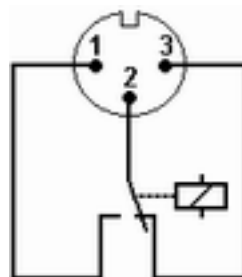

Fig. 17: Flange plug (front) in fault condition

View of the flange plug (front) or into the coupling socket on the soldering side.

Good condition

- Pin 1 and 2 are closed.
- During trouble-free operation, the alarm output is in good state.

Fault condition

- Pin 2 and 3 are closed.
- The alarm output is in fault condition:
 - If the device is switched off,
 - after switching on, if a fault (e.g. low level) is already present,
 - during operation, if a fault occurs, and
 - for each event configured in the *Alarm Output* menu.

Please note the following:

- The equipment connected to the extra-low voltage inputs and outputs must be reliably isolated from voltages dangerous to the touch in accordance with DIN EN 61140. For example, by double or reinforced insulation according to DIN EN 60730-1 or DIN 60950-1.
- Only use protected connection lines. Connect the protective screen with the connector shell. Cover unused connectors with protective caps.

4.7.3 Configuring the Ethernet interface

Technical data of the Ethernet interface

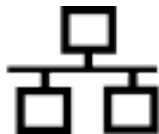

Data	Value	Unit
Ethernet - standard	10/100	MBit

PC control

- The *PC control* menu item enables the device to be accessed by a PC or control station. You activate this function if you want to control or monitor the constant temperature equipment from an external control station.

Before the constant temperature equipment and control station can be operated together in a local network (LAN), the Ethernet interface must be configured.

The Ethernet interface can be configured in two different ways:

- | | |
|--|--|
| Automatically obtain LAN configuration | - In order for this to work, a DHCP server must be present in the local network (LAN). If communication is direct, the control station must support the auto IP standard. |
| Manually configure LAN configuration | - Manual configuration must be performed if a DHCP server is not available, auto IP standard is not supported or you wish to use the Ethernet interface with fixed IP addresses. |

Obtain LAN configuration automatically (DHCP client on)

1. Switch on the constant temperature equipment.
2. Press the [Enter key] to open the menu.
3. Select the menu items from *Setup* → *Basic setup* → *Ethernet* → *LAN configuration* → *DHCP client* using the cursor keys.
 - ▶ The options [Off] and [On] appear on the display.
4. Select the option [On] and press [OK] to confirm.
 - ▶ A check mark is set. The DHCP client is active. The Ethernet interface is configured automatically.

Specify LAN configuration manually (DHCP client off)

5. In the [PC control] menu, select the [on] entry.
 - ▶ A check mark is set. The control for the control station is activated.
 6. If required, enter the port number in the [PC control] menu.
1. Switch on the constant temperature equipment.
 2. Press the [Enter key] to open the menu.
 3. Select the menu items → *Setup* → *Basic setup* → *Ethernet* → *LAN configuration* → *DHCP client*.
 - ▶ The options [Off] and [On] appear on the display.
 4. Select the [Off] option and press the Enter key to confirm.
 - ▶ A check mark is set. The entry has been accepted.
 5. Use the left arrow key to go back one menu level.
 6. Scroll to the numerical values of the [Local IP address] menu item and press the Enter key.
 - ▶ The *Local IP address* menu opens.
 7. Byte 1 is marked. Press the right arrow key.
 - ▶ The entry window opens. The area in which the numerical values can be entered is displayed.
 8. Enter the numerical value for byte 1. Confirm the value with the Enter key [OK].

 *The numerical values are entered byte by byte. From top to bottom, from byte 1 to byte 4, for example 120.0.0.13 (Byte1.Byte2.Byte3.Byte4).*

Press [ESC] to cancel the entry.
 9. Enter the numerical values for byte 2, byte 3 and byte 4.
 10. Once you have entered the numerical values, press the left arrow key.
 - ▶ You return to the *LAN configuration* menu.
 11. Scroll to the numerical values of the [Local mask] menu item and press the Enter key.
 - ▶ The *Local mask* menu opens.
 12. Enter the numerical values, as described in points 7 to 9.
 13. Once you have entered the numerical values, press the left arrow key.
 - ▶ You return to the *LAN configuration* menu.
 14. If required, also enter the numerical values for the [Gateway] and [DNS server].
 15. Once you have entered the numerical values, press the left arrow key.
 - ▶ The entered numerical values of [Local IP address], [Local mask], [Gateway] and [DNS server] are displayed.
 16. Press the [ANW.] softkey to accept the entered numerical values.

17. Press the left cursor key to the move up one menu level and select the *PC control* menu item and press Enter.
18. Confirm the [*PC control*] entry once more.
19. Select the option [*On*] and confirm the entry.
 - ▶ The control for the control station is activated.



No settings are accepted if you leave the LAN configuration menu without first pressing the [ANW.] key.



Set the [DHCP client] from [off] to [on], all numerical values are reset to 0. 0. 0. 0.



If you have set up an Ethernet communication between the control station and the constant temperature equipment, it may take 1 or 2 minutes to establish the connection.

Checking the LAN network

1. Start the Windows command processor by entering `cmd.exe` on the PC with Microsoft Windows operating system.
 - ▶ The entry window will open.
2. There are two ways of checking:
 - Enter the ping command together with the IP address.
`ping xxx.xxx.xxx.xxx`
For "XXX.XXX.XXX.XXX", put the IP address that was entered when the Ethernet interface was configured.
Or
 - Enter the ping command together with the serial number of the thermostatic circulator (possible with software control system 1.36 or later).
`ping serial number`
 - ▶ If the Ethernet interface is configured and connected correctly, the interface will return four responses within a very short time. See Fig. 18.

```

Administrator: C:\Windows\system32\cmd.exe
Microsoft Windows [Version 6.1.7601]
Copyright (c) 2009 Microsoft Corporation. Alle Rechte vorbehalten.

C:\Users\Knoll>ping 172.17.20.22

Ping wird ausgeführt für 172.17.20.22 mit 32 Bytes Daten:
Antwort von 172.17.20.22: Bytes=32 Zeit=1ms TTL=64
Antwort von 172.17.20.22: Bytes=32 Zeit<1ms TTL=64
Antwort von 172.17.20.22: Bytes=32 Zeit<1ms TTL=64
Antwort von 172.17.20.22: Bytes=32 Zeit<1ms TTL=64

Ping-Statistik für 172.17.20.22:
    Pakete: Gesendet = 4, Empfangen = 4, Verloren = 0
    (0% Verlust),
    Ca. Zeitangaben in Millisek.:
    Minimum = 0ms, Maximum = 1ms, Mittelwert = 0ms

C:\Users\Knoll>
  
```

Fig. 18: Example for entering the ping command

Check the LAN network and the process interface

It is easy to check the connection to the interface with a PC and Microsoft Windows operating system.

- For Windows 3.11 with the program "Terminal".
- For Windows 95/98/NT/XP the program "HyperTerminal".
- For operating systems Windows Vista, Windows 7, Windows 8 and Windows 10 "HyperTerminal"* is not part of the operating system.



*Terminal programs are available on the Internet as freeware. These programs offer features similar to "HyperTerminal" (for example PuTTY or RealTerm). Search query "serial port terminal program".

Checking with RealTerm

1. Open the program "HyperTerminal" or the "terminal program" on a PC with Microsoft Windows operating system.
 - ▶ The entry window will open.

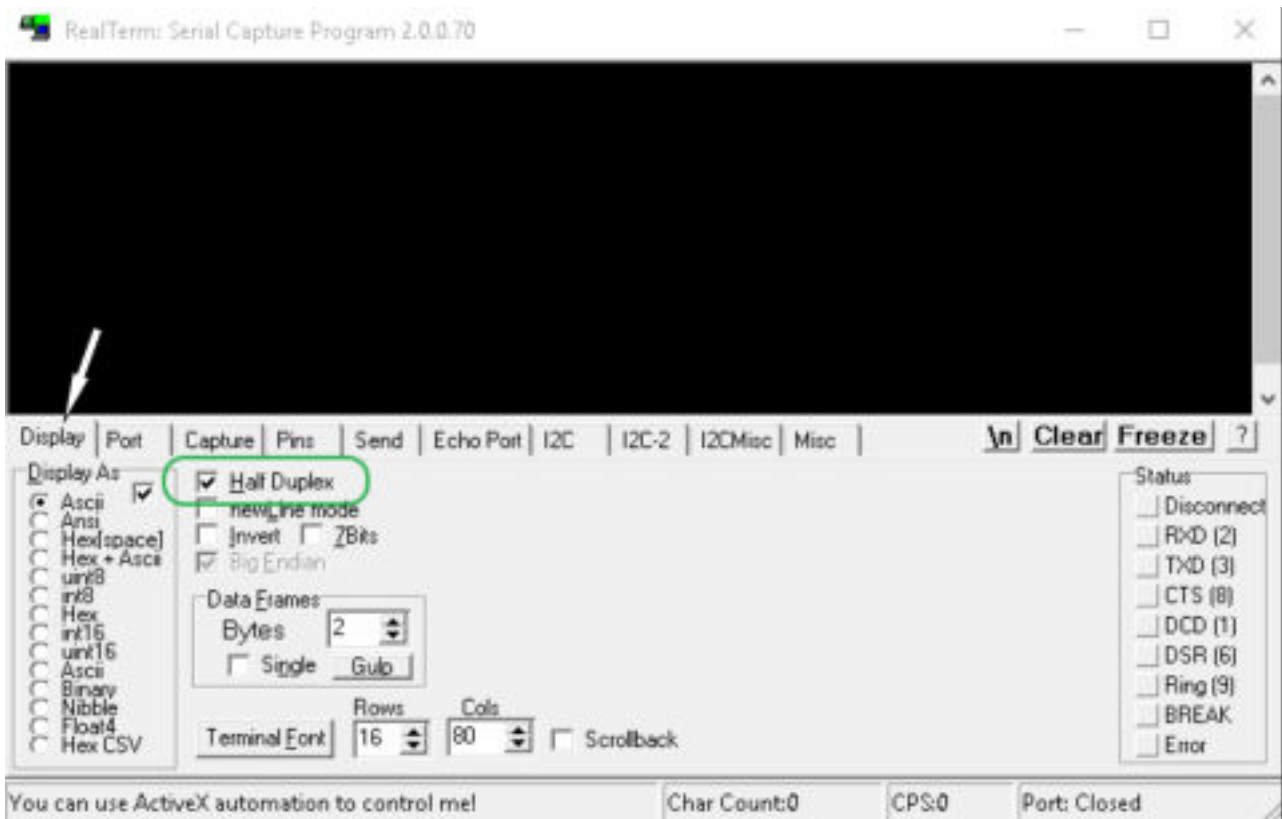

Fig. 19: "RealTerm" program

2. Place a checkmark under *Half Duplex* in the *Display* tab.

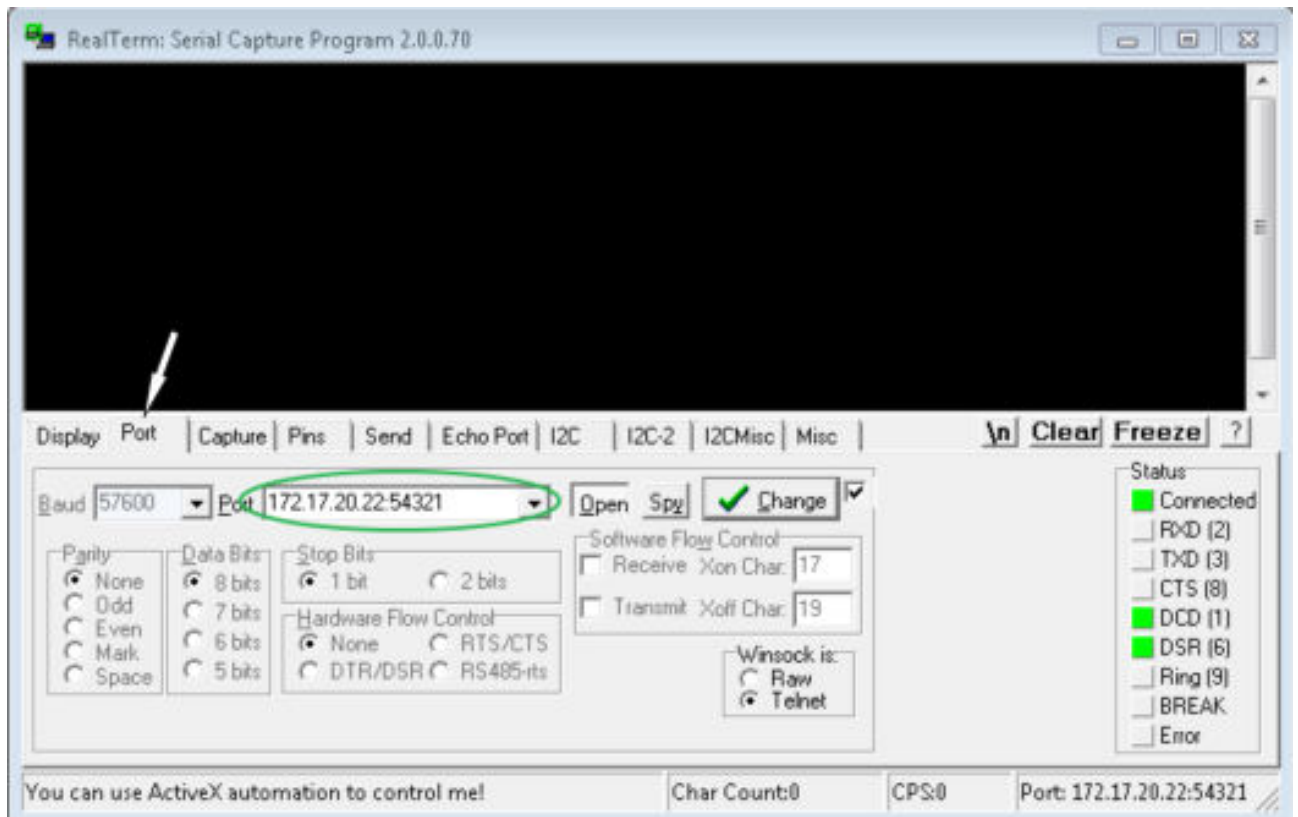

Fig. 20: Entry in the Port field

3. Enter the configured IP address and port number of the Ethernet interface on the constant temperature equipment in the *Port* tab. When you are doing this, be sure that the IP address and port number are separated by a colon.

You can enter the serial number of the constant temperature equipment instead of the IP address.

4. Then press the [Open] button.
5. Open the *Send* tab.
 - ▶ Now that the program has been configured, the actual test can begin.
6. Place a checkmark under *+CR* and *+LF*.

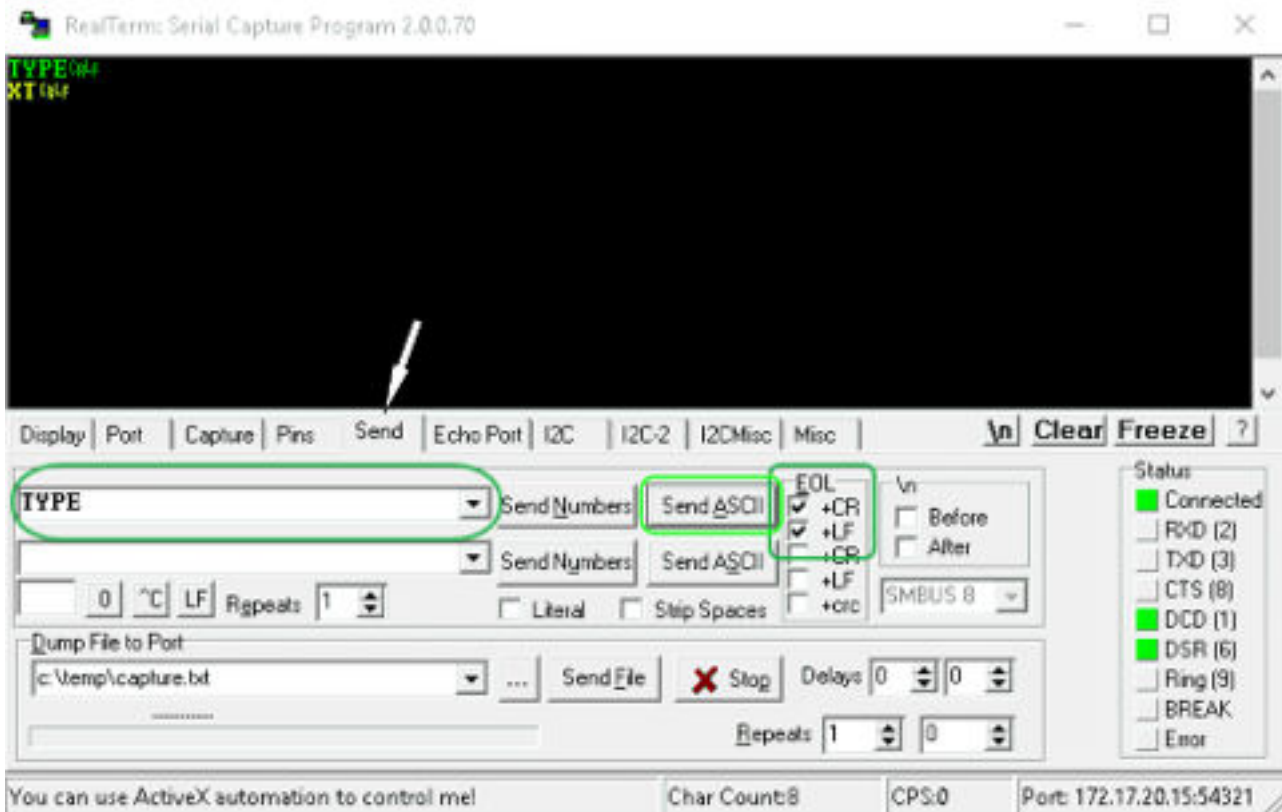

Fig. 21: Entries for the test

7. A command must be sent to the constant temperature equipment to test communication. For example, TYPE. Type the command and press [Send ASCII].
 - ▶ If the connection is operational, the constant temperature equipment acknowledges the command.

4.7.4 Data transfer rate

The data transfer rate cannot be precisely defined. It depends on a variety of different factors:

- Are the constant temperature equipment (with the Ethernet interface) and the control station/PC on the same network?
- Are the control station/PC and constant temperature equipment connected wirelessly (WiFi) or through a cable?
- What is the load on the network?

Generally commands can be sent to the constant temperature equipment every 500 ms. For WiFi connections the period could exceed 1 s. A new command can only be sent if the previous command has been acknowledged by the constant temperature equipment.

4.7.5 Protocol of the interface

Note the following instructions:

- The command from the computer must be made with a CR, CRLF, or LFCR.
- The response from the thermostatic circulator is always made with a CRLF.
- After each command sent to the thermostat, it is necessary to wait for the reply before sending another command. This ensures that the sequencing of inquiries and answers is clear.
CR = Carriage Return (Hex: 0D); LF = Line Feed (Hex: 0A)

Table 9: Example with set point transfer of 30.5 °C to the thermostatic circulator

Computer	Temperature control device
"OUT_SP_00_30.5"CRLF	➔
←	"OK"CRLF

4.7.6 Read commands

The interface module recognizes the following read commands, which you can use to retrieve operating data of the constant temperature equipment.

Table 10: Temperature

ID	Function	Unit, resolution	Command
2	Temperature set point	[°C]	IN_SP_00
3	Outflow temperature	[°C], 0.01 °C	IN_PV_00
4	Outflow temperature	[°C], 0.001 °C	IN_PV_10
5	Controlled temperature (internal / external Pt / external analog / external serial)	[°C]	IN_PV_01
7	External temperature T_E (Pt100)	[°C]	IN_PV_03
8	External temperature T_E (analog input)	[°C]	IN_PV_04
14	External temperature T_E (Pt100)	[°C], 0.001 °C	IN_PV_13
25	Overtemperature turn off point T_{Max}	[°C]	IN_SP_03
27	Limitation of outflow temperature T_{iH} (upper limit)	[°C]	IN_SP_04
29	Limitation of outflow temperature T_{iH} (lower limit)	[°C]	IN_SP_05
33	Set temperature T_{set} in Safe Mode (Safe set point in case of communication interruption).	[°C]	IN_SP_07
158	Actuating signal of master controller in case of external control	[°C]	IN_PV_11

ID	Function	Unit, resolution	Command
162	Overtemperature turn off point, tank	[°C]	IN_SP_12
163	Overtemperature turn off point, outlet	[°C]	IN_SP_13

Table 11: Pump

ID	Function	Unit	Command
6	Outflow pressure / pump pressure, relative to the atmosphere	[bar]	IN_PV_02
12	Through-flow of the pump (MID flow controller must be connected)	[l/min]	IN_PV_07
18	Pump power stage (only for Integral XT)	[-]	IN_SP_01
31	Outflow pressure / pump pressure setpoint (only applies to Integral XT with pressure control settings)	[bar]	IN_SP_06
37	Through-flow control set point (MID flow controller must be connected)	[l/min]	IN_SP_09
71	Status of through-flow control: 0 = off / 1 = on	[-]	IN_MODE_05
154	Outflow pressure of flow controller, relative to the atmosphere (MID flow controller must be connected)	[bar]	IN_PV_09
156	Pressure limitation set point with active through-flow control (MID flow controller must be connected)	[bar]	IN_SP_10
157	Overpressure turn off point with active through-flow control (MID flow controller must be connected)	[bar]	IN_SP_11
160	Valve position of the flow controller (MID flow controller must be connected)	[%]	IN_PV_12

Table 12: Fill level

ID	Function	Unit	Command
9	Heat transfer liquid level (fill level)	[-]	IN_PV_05
10	Signal refilling	[-]	

Table 13: Actuating signal

ID	Function	Unit, resolution	Command
11	Resolution of controller actuating signal in per mill – negative value → device is cooling – positive value → device is heating	[%]	IN_PV_06
13	Controller actuating signal in watts – negative value → device is cooling – positive value → device is heating	[W]	IN_PV_08

Table 14: Cooling

ID	Function	Unit	Command
24	Cooling mode: 0 = off / 1 = on / 2 = automatic	[-]	IN_SP_02

Table 15: Safety

ID	Function	Unit	Command
35	Timeout communication via interface (1 – 600 seconds; 0 = Off)	[s]	IN_SP_08
73	Status of Safe Mode: 0 = off (inactive) / 1 = on (active)	[-]	IN_MODE_06

Table 16: Control parameters

ID	Function	Unit	Command
39	Control parameter Xp	[-]	IN_PAR_00
41	Control parameter Tn (181 = Off)	[s]	IN_PAR_01
43	Control parameter Tv	[s]	IN_PAR_02
45	Control parameter Td	[s]	IN_PAR_03
47	Control parameter KpE	[-]	IN_PAR_04
49	Control parameter TnE	[s]	IN_PAR_05
51	Control parameter TvE	[s]	IN_PAR_06
53	Control parameter TdE	[s]	IN_PAR_07
55	Correction limitation	[K]	IN_PAR_09
57	Control parameter XpF	[-]	IN_PAR_10
61	Control parameter Prop_E	[K]	IN_PAR_15

Table 17: Control

ID	Function	Unit	Command
59	Set point offset	[K]	IN_PAR_14
67	Control in control variable X: 0 = internal / 1 = external Pt / 2 = external analog / 3 = external serial / 5 = external Ethernet / 6 = external EtherCAT / 7 = external Pt 2 (only for Integral)	[-]	IN_MODE_01
69	Offset source X for set point: 0 = normal / 1 = external Pt / 2 = external analog / 3 = external serial / 5 = external Ethernet / 6 = external EtherCAT / 7 = external Pt 2 (only for Integral)	[-]	IN_MODE_04

Table 18: Rights

ID	Function	Unit	Command
63	Status of Master keyboard: 0 = free / 1 = blocked	[-]	IN_MODE_00
65	Status of remote control keyboard: 0 = free / 1 = blocked	[-]	IN_MODE_03

Table 19: Status

ID	Function	Unit	Command
75	Status of standby: 0 = Device is switched on / 1 = Device is switched off	[-]	IN_MODE_02
107	Device type (e.g.: "INT" or "INXT")		TYPE
130	Device status: 0 = OK / -1 = fault	[-]	STATUS
131	Fault diagnosis; a 7-digit answer in the format XXXXXXX is output, whereby each character X contains fault information (0 = no fault / 1 = fault). The following information is defined for the seven places of the answer format: <ul style="list-style-type: none"> ■ 1st character = Error ■ 2nd character = Alarm ■ 3rd character = Warning ■ 4th character = Overtemperature ■ 5th character = Low level ■ 6th character = 0 (with alarm setting: High level) ■ 7th character = External control value missing 	[-]	STAT
161	Serial numbers	[-]	SERIAL_NO

Table 20: Programmer

ID	Function	Unit	Command
77	Program used as a basis for further commands	[-]	RMP_IN_04
88	Current segment number	[-]	RMP_IN_01
90	Number of preset program sequences	[-]	RMP_IN_02
92	Current program loop	[-]	RMP_IN_03
94	Currently running program (0 = no program currently running)	[-]	RMP_IN_05

Table 21: Contact input / output

ID	Function	Unit	Command
96	Contact input 1: 0 = open / 1 = closed	[-]	IN_DI_01
98	Contact input 2: 0 = open / 1 = closed	[-]	IN_DI_02
100	Contact input 3: 0 = open / 1 = closed	[-]	IN_DI_03

ID	Function	Unit	Command
102	Contact output 1: 0 = open / 1 = closed	[-]	IN_DO_01
104	Contact output 2: 0 = open / 1 = closed	[-]	IN_DO_02
106	Contact output 3: 0 = open / 1 = closed	[-]	IN_DO_03

Table 22: SW version

ID	Function	Unit	Command
108	Control system	[-]	VERSION_R
109	Protection system	[-]	VERSION_S
110	Remote control (Command) (remote control unit must be present)	[-]	VERSION_B
111	Cooling system (only for devices with active cooling)	[-]	VERSION_T
112	Analog interface module (interface module must be present)	[-]	VERSION_A
113	Flow controller (flow controller must be present)	[-]	VERSION_A_1
114	RS 232/485 interface module or Profibus/Profinet/CAN (interface module must be present)	[-]	VERSION_V
116	EtherCAT interface module (interface module must be present)	[-]	VERSION_Z
117	Contact interface module (interface module must be present)	[-]	VERSION_D
118	Solenoid valve for cooling water (Solenoid valve must be present)	[-]	VERSION_M_0
119	Solenoid valve for automatic filling device (Solenoid valve must be present)	[-]	VERSION_M_1
120	Solenoid valve for constant level device (Solenoid valve must be present)	[-]	VERSION_M_2
121	Solenoid valve, shut off valve 1 (Solenoid valve must be present)	[-]	VERSION_M_3
122	Solenoid valve, shut off valve 2 (Solenoid valve must be present)	[-]	VERSION_M_4
124	Pump 1	[-]	VERSION_P_0
125	Pump 2 (only applies to devices with a double pump or supplementary pump)	[-]	VERSION_P_1
126	Heating system 1	[-]	VERSION_H_0
127	Heating system 2 (only applies to devices with a heater > 16 kW)	[-]	VERSION_H_1

ID	Function	Unit	Command
128	External Pt100 interface 1 (an external temperature module must be present)	[-]	VERSION_E
129	External Pt100 interface 2 (a second external temperature module must be present)	[-]	VERSION_E_1

Table 23: Pressure overlay

ID	Function (only applies to devices with pressure overlay)	Unit	Command
165	Set pressure for pressure overlay	[bar]	IN_SP_14
166	Tank pressure of pressure overlay	[bar]	IN_PV_14
168	Pressure overlay hysteresis	[bar]	IN_SP_15

4.7.7 Write commands

The interface module recognizes the following write commands, which you can use to transfer values to the constant temperature equipment.

The control station obtains operator privileges when sending a write command. This only works if the control station has not been locked by another control element. ↪ Chapter 6.21 “Operator and viewer” on page 120



The constant temperature equipment confirms each write command with OK, e.g. the reply from the device address A015 is "A015_OK". In the event of an error, an error message is output as a reply, e.g. "A015_ERR_6". ↪ Chapter 4.7.8 “Error messages” on page 61

Table 24: Temperature

ID	Function	Unit	Command
1	Temperature set point	[°C]	OUT_SP_00_XXX.XX
15	Actual value of external temperature (via interface)	[°C]	OUT_PV_05_XXX.XX
26	Limitation of outflow temperature TiH (upper limit)	[°C]	OUT_SP_04_XXX.XX
28	Limitation of outflow temperature TiH (lower limit)	[°C]	OUT_SP_05_XXX.XX
32	Temperature set point T_{set} in Safe Mode	[°C]	OUT_SP_07_XXX.XX

Table 25: Pump

ID	Function	Unit	Command
17	Pump power stage 1 – 8 (only for Integral XT)	[-]	OUT_SP_01_XXX
30	Setpoint (only applies to Integral XT with pressure control settings)	[bar]	OUT_SP_06_X.XX

ID	Function	Unit	Command
36	Through-flow control set point (MID flow controller must be connected)	[l/min]	OUT_SP_09_X.XX
70	Activate through-flow control: 0=Switch = switch off / 1 = switch on	[-]	OUT_MODE_05_X
155	Pressure limitation set point with active through-flow control (MID flow controller must be connected and equipped with an integrated pressure sensor)	[bar]	OUT_SP_10_X.X
159	Actual value of external pressure control variable (via interface)	[bar]	OUT_PV_06_XX.XX

Table 26: Cooling

ID	Function	Unit	Command
23	Cooling mode: 0 = off / 1 = on / 2 = automatic	[-]	OUT_SP_02_XXX

Table 27: Safety

ID	Function	Unit	Command
34	Timeout communication via interface (1 – 600 seconds; 0 = Off)	[s]	OUT_SP_08_XXX
72	Activate Safe Mode	[-]	OUT_MODE_06_1

Table 28: Control parameters

ID	Function	Unit	Command
38	Control parameter Xp	[-]	OUT_PAR_00_XX.X
40	Control parameter Tn (5 – 180 s; 181 = Off)	[s]	OUT_PAR_01_XXX
42	Control parameter Tv	[s]	OUT_PAR_02_XXX
44	Control parameter Td	[s]	OUT_PAR_03_XX.X
46	Control parameter KpE	[-]	OUT_PAR_04_XX.XX
48	Control parameter TnE (0 – 9000 s; 9001 = Off)	[s]	OUT_PAR_05_XXXX
50	Control parameter TvE (5 = Off)	[s]	OUT_PAR_06_XXXX
52	Control parameter TdE	[s]	OUT_PAR_07_XXXX.X
54	Correction limitation	[K]	OUT_PAR_09_XXX.X
56	Control parameter XpF	[-]	OUT_PAR_10_XX.X
60	Control parameter Prop_E	[K]	OUT_PAR_15_XXX

Table 29: Control

ID	Function	Unit	Command
58	Set point offset	[K]	OUT_PAR_14_XXX.X
66	Control in control variable X: 0 = internal / 1 = external Pt / 2 = external analog / 3 = external serial / 5 = external Ethernet / 6 = external EtherCAT / 7 = external Pt 2 (only for Integral)	[-]	OUT_MODE_01_X
68	Offset source X for set point: 0 = normal / 1 = external Pt / 2 = external analog / 3 = external serial / 5 = external Ethernet / 6 = external EtherCAT / 7 = external Pt 2	[-]	OUT_MODE_04_X

Note (ID 66 and 68): If X = 3, the commands ID 66 and ID 68 cannot be executed in some constant temperature control devices until an external temperature specification has been received (via the command ID 15).

Table 30: Rights

ID	Function	Unit	Command
62	Master keyboard (equivalent to "KEY"): 0 = unlock / 1 = lock	[-]	OUT_MODE_00_X
64	Keyboard remote control unit (command): 0 = unlock / 1 = lock	[-]	OUT_MODE_03_X

Table 31: Status

ID	Function	Unit	Command
74	Switch the device on / off (standby)	[-]	START / STOP

Table 32: Programmer

ID	Function	Unit	Command
76	Select the program for the subsequent commands (X = 1 – 5). The default program is 5 when the constant temperature equipment is switched on. Caution! Executing this command may stop any programs that are currently running.	[-]	RMP_SELECT_X
78	Start programmer	[-]	RMP_START
79	Pause programmer	[-]	RMP_PAUSE
80	Continue programmer (after pause)	[-]	RMP_CONT
81	End programmer	[-]	RMP_STOP

Table 33: Pressure overlay

ID	Function (only applies to devices with pressure overlay)	Unit	Command
164	Set pressure for pressure overlay	[bar]	OUT_SP_14_XXX
167	Pressure overlay hysteresis	[bar]	OUT_SP_15_XXX

4.7.8 Error messages

The error messages of the Ethernet interface are described in the following. The string *ERR_X* or *ERR_XX* is output after an incorrect command.

Error	Description
ERR_2	Incorrect entry (for example, buffer overflow)
ERR_3	Wrong command
ERR_5	Syntax error in value
ERR_6	Impermissible value
ERR_8	Module or value not available
ERR_30	Programmer, all segments occupied
ERR_31	Not possible to specify a set point value. The "Setpoint offset" function is active.
ERR_32	$TiH \leq TiL$
ERR_33	External sensor missing
ERR_34	Analog value not present
ERR_35	Automatically configured
ERR_36	Not possible to specify set point, programmer is running or has been paused
ERR_37	Not possible to start programmer (analog set point value input is ON)
ERR_38	The operator does not have the privileges to execute the command. Another control section has exclusive operating rights, which means that writing via this interface is not permitted.
ERR_39	Operation is not permitted. Safe Mode is active.
ERR_40	Operation is not permitted. Safe Mode is switched off.
ERR_41	Operation is not permitted. Constant temperature equipment is in error status.

5 Commissioning

Please refer to the information in Chapter ↗ Chapter 8 “Operating a device with pressure overlay” on page 136 for devices with pressure overlay.

5.1 Establishing a mains connection



WARNING!
Contact with voltage conductors due to faulty mains cable

Electric shock

- The mains cable may not come into contact with hot heat transfer liquid and other hot parts, neither during operation nor after the device is switched off.



NOTICE!
Use of impermissible mains voltage or mains frequency

Device damage

- Compare the rating label with the available mains voltage and mains frequency.

Personnel: Operating personnel

Please note:

1. Only connect the device with a mains cable to a socket with a protective earth conductor (PE) and only use the installed mains cable for the power supply.
2. The mains switch disconnects the device from the power unit. The mains switch must be easy to identify and access.



Note for IN 2560 XTW and IN 2560 PW

The mains cable is not supplied. With regard to the connection, see ↗ “Power supply at IN 2560 XTW and IN 2560 PW” on page 63.

The note only applies to devices in the USA and Canada

Note for electric installation on site

- We recommend LAUDA that a back-up fuse is installed on the installation side for three-phase devices: 25 A class cc low peak

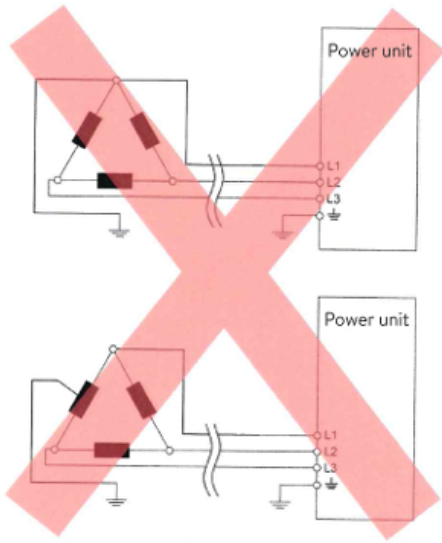

Fig. 22: Asymmetrically grounded delta network (without isolating transformer)

Power supply at IN 2560 XTW and IN 2560 PW

Notes for electric installation on site

- The fuse on the installation side must at least correspond to the maximum current consumption of the device (see type plate) and may not exceed the value permitted for the mains plug.
- Three-phase devices
 - Three-phase devices may only be operated on networks grounded at the neutral point, e.g. TN-C, TN-C-S or TN-S. For ungrounded networks (e.g. IT systems) or asymmetrically grounded networks, an isolating transformer must be connected upstream and the neutral point grounded. When selecting the isolating transformer, consider the maximum connected loads of the device.
 - Ensure correct rotating field! If the rotating field is incorrect, an error message is displayed and the device cannot be put into operation.



CAUTION!
Use of a mains cable with impermissible dimensions

Fire hazard, smoke generation

- The specifications on the type plate of the device are decisive for the cross-section of the mains cable. Comply with the national regulations of the respective country when installing the mains cable.

Instructions for the electrical installation of the mains cable in the building:

- The mains cable must be installed by a qualified electrician.
- The mains cable must be installed on site by the user. The installation is implemented with hard wiring or with an approved plug with an adequate rating.
- For three-phase devices, the rating of the circuit breaker must at least match the **current consumption** of the device. The value will be found on the type plate. Follow the national regulations relating to electrical installations in the respective country.

Installation of the mains cable in the device

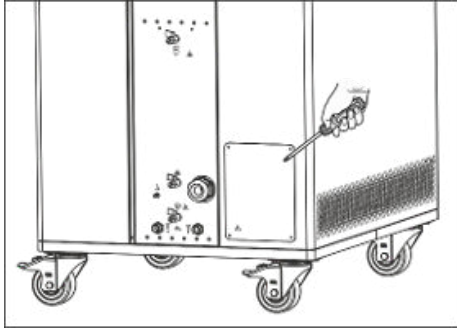

Fig. 23: Covering plate in front of the connection box

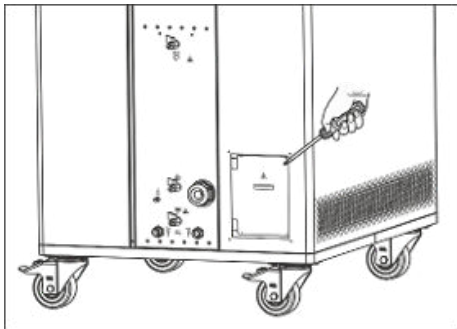

Fig. 24: Connection box cover

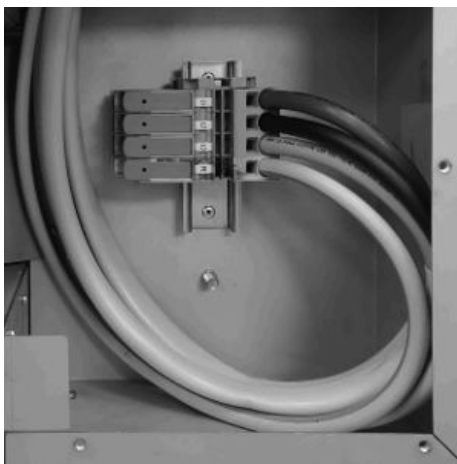

Fig. 25: Terminals in the connection box

Cable gland

Personnel: ■ Specialized personnel

1. Unscrew the covering plate on the right-hand side of the device.
2. Unscrew the cover of the connection box.
3. Undo the union nut of the cable gland.
4. Insert the end of the mains cable through the cable gland.
5. Pull the mains cable towards the terminals.
6. Open the lever of the terminal as far as it will go.

7. Insert the appropriate conductor in the terminal.



The terminals are suitable for solid conductors, fine-stranded conductors and fine-stranded conductors with a ferrule.

8. Close the lever until it first engages and continue until it finally engages.

- ▶ The conductor has been connected.

9. Correctly connect the remaining conductors.



A ground terminal is mounted in the connection box in addition to the feed-through terminals. There is also a ground stud in the connection box.

10. Tighten up the union nut of the cable gland.
11. Screw the covers back onto the device.



Correct rotating field on the three-phase device

The device with a three-phase power supply checks that the rotating field is correct when it is switched on and outputs a warning if necessary.

- The cable gland mounted on the device is suitable for cable diameters 22-31 mm.
A larger cable gland for cable diameters 26-35 mm is enclosed with the device. Remove the bushing and replace the mounted cable gland with the enclosed cable gland to install the thicker cable.

5.2 Switching on the device for the first time

You will find the entry sequence prescribed for safety reasons in the graphic. The entries must be input each time the heat transfer liquid is changed and after the device has been switched on for the first time.

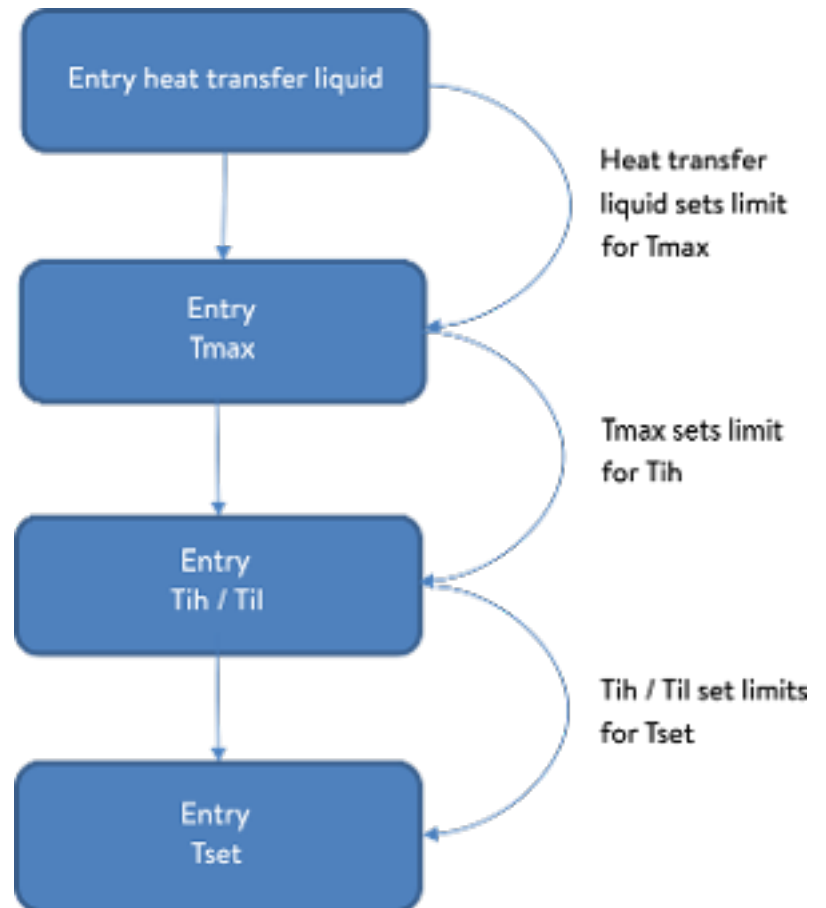

Fig. 26: Entry sequence

Switch on the device



Fig. 27: Start screen

1. Switch on the device at the mains switch. A signal tone is emitted.
 - ▶ Then the menu to choose the language appears.



Fig. 28: Menu language

2. Use the up and down arrow keys to select the desired [menu language].
Press [CONTINUE] softkey to confirm your selection.



You can change the menu language at any time via the menu.

- ▶ The menu for selecting the time zone then appears.
3. Use the down and up arrow keys to select the [Time zone] that you are in.
Press [CONTINUE] softkey to confirm your selection.
 - ▶ Then the menu to choose the heat transfer liquid appears.
 4. Use the down and up arrow keys to select the [heat transfer liquid].
Press [CONTINUE] softkey to confirm your selection.
 - ▶ Then the fill mode menu appears.
 5. Fill the device with heat transfer liquid.
 - ▶ Then the degas mode menu appears.
 6. Let the device perform the degassing.
 7. Set $T_{max/Tank}$ → Chapter 6.4 “Setting Tmax” on page 88.



When the device is in operation, a red light spot is projected onto the floor under the front of the device.

If there is a fault, this light point flashes. If the device is in standby or switched off, the light point is not present.

5.3 Operating the device with the operating unit

5.3.1 Home window, navigation and softkeys

Home window

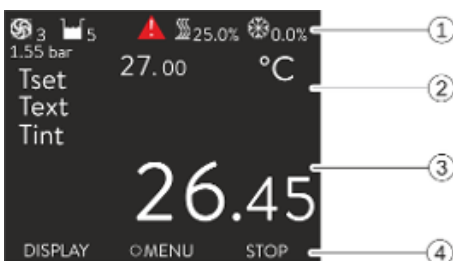

Fig. 29: Home window with status bar and softkey bar

After switching on the device and configuring the settings, the "simple" home window (without status bar) is displayed. If no entry is made for about 10 seconds, the softkey bar is hidden. Press any key to display the softkey bar again.

- 1 Status bar
- 2 Display of the external temperature T_{ext} or the internal temperature T_{int} and the set temperature T_{set} .
- 3 Large display of the temperature according to which the device is regulated.
- 4 The softkey assignments are displayed in the softkey bar.

The softkeys are special keys that can be pressed at any time, but can assume different functions depending on the context. The respective function is shown in the display at the assigned position.

Status bar

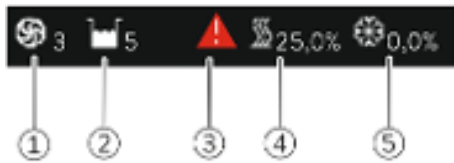

Fig. 30: Status bar from the extended home window

- 1 When the pump is running, the pump symbol rotates. Only for Integral XT will the pump level be additionally displayed as a figure.
- 2 Display of the filling level of the heat transfer liquid in the device
- 3 A red or yellow warning triangle indicates error, alarm or warning messages.
- 4 The heater heats with the displayed percentage power.
- 5 The cooling unit cools with the displayed percentage power.

Keys, displays and softkeys

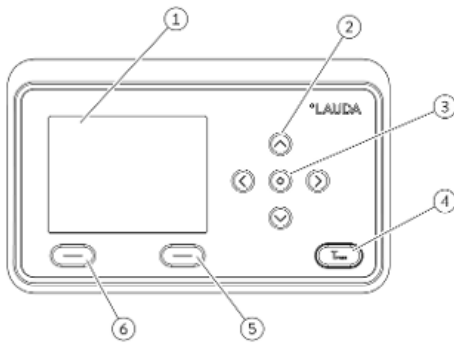

Fig. 31: Operating unit (transverse format design)

- 1 Display
 - 2 4 arrow keys
 - 3 Enter key
 - 4 Key to display the overtemperature switch-off point
 - 5 Right softkey
 - 6 Left softkey
- To go from the home window to the main menu, press Enter.
 - Navigate with the four arrow keys
 - You can scroll up and down in the menu using the arrow keys.
 - If you are in the main menu, pressing the right arrow key [>] (several times) or the Enter key [MENU] takes you deeper into the menu.
 - If you are in a submenu, you can return to the home window by pressing the left arrow key [<] several times.

Symbols in the menu

Symbol	Description
	The triangle indicates that there is a submenu.
	The padlock indicates that this menu cannot be changed.

Functions of the softkeys

The softkey bar is located at the bottom of the display. Depending on the context, the softkeys are assigned several different functions.

You can select the following functions with the softkeys:

- With [DISPLAY] you switch through the different windows.
 - "simple" home window (without status bar)
 - "extended" home window (with status bar)
 - Graph window
 - List with errors and code number
 - List with warnings and code number
 - List with alarms and code number
- With [ESC] you exit the menu and jump back into the home window or exit an entry window.
- With [MENU]
 - you access the main menu and
 - confirm the selected menu command which takes you deeper into the submenu or to an entry window.

- With [OK]
 - you confirm an option in a selection window and
 - confirm a numerical value in an entry window.
- With [CHANGE] a device parameter (for example set temperature) is changed.
- With [SELECT] an element is selected in a selection list.
- With [START] or [STOP] you can switch between the two operating modes *Standby* and *Operation*.
- With [+/-] you can enter negative values in an entry window.
- Depending on the context, further functions are assigned to the soft-keys (e.g. NEW/DELETE in the programmer-editor).

5.3.2 Enter entry window and set temperature

Settings in the display are configured via the entry window. Two varieties of entry windows are available.

Entry window for selecting options



Fig. 32: Selecting options

- The check mark indicates the active option.
- You can navigate in the options using the arrow keys [up] and [down].
- The selected option is highlighted.
- Press the [ESC] softkey to exit the entry window, with or without changes.
- Press the Enter key [OK] to accept the selected option.

Entry window for a numerical value



Fig. 33: Entering a value

- The value to be entered is displayed in enlarged font. The cursor flashes under the value.
- With the [up] and [down] arrow keys you can change the value. If you keep one of the two arrow keys pressed down longer, the change will be accelerated.
- By pressing the [left] or [right] arrow key, you can select individual digits and change them with the [up] and [down] arrow keys.
- With the [+/-] softkey you can change the sign of the value.
- The displayed values *Max:* and *Min:* specify the limits for the value entry.
- With the [ESC] softkey, you return to the previous display without making any changes.
- By pressing the Enter key [OK], the set value is accepted.

Entering set temperature

1. Press the Enter key to open the menu.
2. Select the → *Set temperature* menu item.

3. Press the Enter key.
 - ▶ The entry window appears. The cursor flashes under the temperature value. The upper and lower temperature range is displayed.
4. Change the value with the arrow keys.



By pressing the [ESC] key, you return to the previous menu without making any changes.

5. Press the [OK] to confirm the new value.
 - ▶ The new value is active.

5.3.3 Graph window

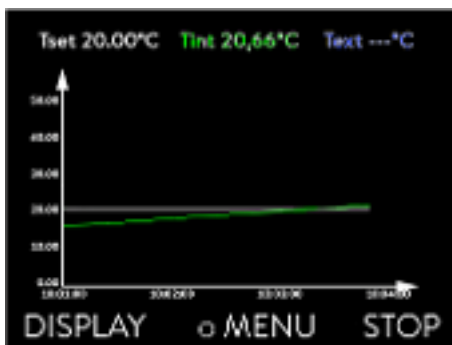

Fig. 34: Graph window

The display offers you the possibility to display temperature curves graphically.

The graphics window can be accessed via the [Display] softkey in the home window of the display.

- T_{set} indicates the set temperature (gray).
- T_{int} indicates the internal temperature (green) of the heat transfer liquid in the device.
- T_{ext} indicates the external temperature (dark blue) of the heat transfer liquid in the application.
- Use the arrow keys to scroll the graphic in any direction.

Edit the graphic window

1. Press the Enter key to open the menu.
2. Select the → Graphic menu item.
 - ▶ The Graphic submenu opens.

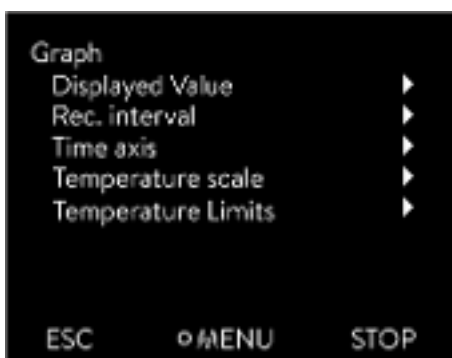

Fig. 35: Graphic menu

In this submenu, you can adapt the graphics window to your requirements.

- [Display measurement values]: T_{set} , T_{int} , T_{ext} and T_{ext2} .
Here you can define which temperatures are displayed in the graph.
- [Sample time]: 2 s (maximum 50 min), 10 s (maximum 4 h), 30 s (maximum 12 h), 1 min (maximum 24 h) or 2 min (maximum 48 h).
Here you can define the time interval at which new temperature values are measured.
- [Time Axis]: auto, 9 min, 45 min, 2 h15 min, 4 h30 min, 9 h, 24 h or 48 h.
Here you can define the time range displayed in the visible graph window (corresponds to scaling of x axis).

- [Temperature scale]: automatic or manual.
Here you can define which temperature range is displayed in the visible graph window.
 - [Autom.]: The size of the visible graphic area automatically adapts to the changing temperature curves.
 - If the setting is selected automatically, the following menu item (Temperature limits) is not visible.
- [Temperature limits]: T.scale Min and T.scale Max.
Here you can manually define which time range is displayed in the visible graph window.

5.3.4 Operate the device using the Command Touch unit

The device can also be operated with the Command Touch remote control unit (accessory).

	WARNING! Device start carried out from remote control unit
Scalding, cold burns	<ul style="list-style-type: none"> ● Switch the local operating unit into standby

5.4 Setting heat transfer liquid

	WARNING! Overheating of heat transfer liquid due to incorrect entry of overtemperature switch-off point T_{max} for the hydraulic circuit
Fire	<ul style="list-style-type: none"> ● Set the overtemperature switch-off point for the hydraulic circuit to 5 K above the upper limit of the temperature range for your application. But not above the upper limit of the working temperature range of the heat transfer liquid.

The following information is only relevant for the Integral T device:

	WARNING! Overheating of heat transfer liquid due to incorrect entry of overtemperature switch-off point T_{max} for the hydraulic circuit
Fire	<ul style="list-style-type: none"> ● In the menu of the device, set the heat transfer liquid used in the device. Set the overtemperature switch-off point <u>below</u> the flash point of the heat transfer liquid.

The following information is only relevant for the Integral XT device:



WARNING!

Overheating of heat transfer liquid due to incorrect entry of overtemperature switch-off point $T_{\max/\text{Tank}}$ for the expansion vessel

Fire

- In the menu of the device, set the heat transfer liquid used in the device. Set the overtemperature switch-off point $T_{\max/\text{Tank}}$ below the flash point of the heat transfer liquid.

In the menu of the device, set the heat transfer liquid used in the device. This process loads the values entered in the software into the controller of the device.

The entered values of the heat transfer liquid are:

- the flash point
- the viscosity
- the density
- the specific heat capacity
- the limits of the working temperature range in the hydraulic circuit
- the limits of the temperature range in the expansion vessel (only for Integral XT)

If you select the heat transfer liquid setting [Undefined], you can enter the properties of a new heat transfer liquid in the [Define heat transfer liquid] menu item.

Personnel: Operating personnel

1. Press the Enter key to open the menu.
2. Select the menu items → Setup → Fluid → Select fluid.
 - ▶ A list of the approved heat transfer liquids for the device is displayed.
3. Scroll to mark a heat transfer liquid.



By pressing the [ESC] key, you return to the home menu without making any changes.

4. Press [OK] to confirm the selection.
 - ▶ The selection is marked with a checkmark.
5. In the menu item → Display fluid properties, you can display the properties of the heat transfer liquid.



Set Tmax immediately

After you have selected the heat transfer liquid, immediately set the overtemperature switch-off points $T_{\max/\text{tank}}$ $T_{\max/\text{Tank}}$
 ↪ Chapter 6.4 “Setting Tmax” on page 88.

5.5 Fill the device with heat transfer liquid

LAUDA is not liable for damages resulting from the use of unsuitable heat transfer liquids.

Do not mix different heat transfer liquids together!

Use a funnel if required to fill the device with heat transfer liquid.
The filling of a device with a pressure pump (mandatory in IN 2560 XTW) is described in ↗ “Filling with a pressure pump” on page 75.

The filling of devices with pressure overlay is described in ↗ “Filling with heat transfer liquid” on page 141.



DANGER!
Use of unsuitable heat transfer liquid

Fire

- Select a heat transfer liquid with a temperature range suitable for the application.



WARNING!
Overheating of the heat transfer liquid

Fire

- The heat transfer liquid used in the device must be set in the menu of the device.



WARNING!
Risk of heat transfer liquid overheating due to incorrect entry of overtemperature switch-off point T_{max}

Fire

- Set the overtemperature switch-off point to 5 K above the upper limit of the temperature range for your application. The overtemperature switch-off point must be below the flash point of the heat transfer liquid.



WARNING!
Splashing heat transfer liquid

Eye damage

- Always wear suitable safety glasses when working on the device.



WARNING!
Overflow of heat transfer liquid

Electric shock

- Do not overfill the device. Observe the level display and the thermal volume expansion of the heat transfer liquid.



WARNING!
Spraying of heat transfer liquid

Electric shock

- Do not spray heat transfer liquid. Use a funnel for filling.



WARNING!
Overflow of heat transfer liquid due to increase in volume caused by heating

Scalding, electric shock

- Take into account the increase in volume caused by heating of the heat transfer liquid.



CAUTION!
Risk of heat transfer liquid escaping

Slipping hazard

- Draining tap must be closed.



CAUTION!
Heat transfer liquid escaping from the overflow pipe

Slipping hazard

- Use a collecting vessel on the overflow.



Heat transfer liquids expand when heated (approx. 10 % for every 100 °C). If an external consumer is connected, the total expansion occurs in the tank of the thermostat.

- Avoid ignition sources in the vicinity of the cover and overflow hose.
- There must be no gas cushions in the consumer system.

Information on filling the device

- Refilling during operation is possible.
- Only operate the thermostat if a flow in the consumer system is possible. Open any shut-off valves in the consumer.
- During filling, the device may overflow if the consumer is positioned higher than the device and filling is interrupted (e.g. due to a power failure). There may be even larger amounts of air in the consumer, which allows the filled liquid to flow back. In case of doubt, a shut-off valve should be attached to the lower connection of the application.
- A vent valve Fig. 36 can significantly simplify the aeration process. For this purpose, periodically open the valve carefully and allow gas/air to escape until liquid escapes from the valve, and then close the vent valve again. Collect the liquid in a suitable container. Operate the valve again at regular intervals until no more air escapes.

Notes on fill mode in Integral XT

- The fill mode (only in Integral XT) supports you in filling the device. Messages in the display guide you through the filling process. Follow the instructions and switch on the display with the [>>] softkey.
- Furthermore, the fill mode removes gas bubbles and air bubbles from the thermostatic circuit. The pump starts automatically at pump level 2 (IN 2560 XTW/PW: pump level 4) and switches off briefly every 45 seconds for better aeration. Heating and cooling unit are switched off. Observe the pressure indication and level indication until the level no longer drops, the pressure indication no longer rises and the degassing symbol is no longer displayed for at least two minutes. Venting takes at least a few minutes and can take more than an hour in unfavorable conditions with large-volume consumers and high viscosity.
- For high-temperature thermostats, the switchover between the individual hydraulic paths takes place alternately every 20 seconds. This produces a buzzing sound of about 5 seconds. The displayed pressure changes periodically.

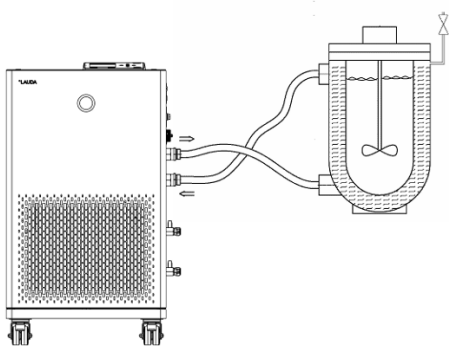

Fig. 36: Application with vent valve

Fill an empty device

- Protective equipment:
- Safety glasses
 - Protective gloves
 - Protective work clothing

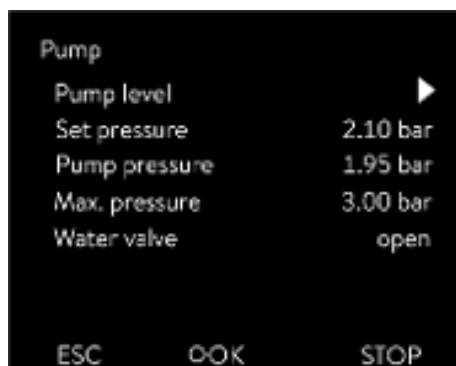

Fig. 37: Pump menu in Integral XT

1. Close the drain tap or taps. To do this, turn the tap clockwise.
2. Attach a suitable hose (heat transfer liquid/temperature) to the overflow connection on the device.
3. Place the end of this hose into a suitable canister to collect the overflowing heat transfer liquid.
4. Switch on the device.
You can also switch the Integral T into standby.
 - ▶ Only for Integral XT: If the tank is empty (level 0), the *fill mode* is started immediately after switching on the device.
5. Remove the tank lid. Use a funnel for filling, if required.
6. Carefully fill the heat transfer liquid. Check the level indicator and do not overflow the device!

Recommendation: Fill the device up to level 6.

7. Integral T: Switch on the pump and fill the application. The level in the device drops.
8. Carefully top up the heat transfer liquid. Check the level indicator and do not overfill the device!

From level 10 for Integral T or level 11 for Integral XT the device additionally supports you with a sound. At the beginning, the sound is emitted at larger time intervals. From level 12, the sound is repeated at shorter intervals. Once the **fill maximum is reached**, a continuous tone is output.

Filling with a pressure pump



Note on filling the IN 2560 XTW

The IN 2560 XTW can only be filled with a pressure pump; this is optional for all other devices.

We recommend the B2 Vario drum pump from Lutz for non-flammable heat transfer liquids.

The device is filled via the filling nozzle with the non-return valve.

The constant temperature equipment has been switched off and compressed air is not required for filling.

1. Completely assemble the hydraulic circuit (with application, hoses, constant temperature equipment and any additional equipment).
2. Prepare the heat transfer liquid.
3. Immerse the pressure pump in the container with the heat transfer liquid.
4. Unscrew the sealing cap from the filling nozzle of the device. See the item "Filling nozzle with non-return valve" in the device graphic in Fig. 7 or Fig. 8.
5. Connect the drum pump to the filling nozzle of the device (G 3/8" exterior thread (male)).
6. Open the filling tap. To do this, turn the tap counterclockwise.
7. Switch on the constant temperature equipment with the mains switch and switch it to standby.
Have the fill level of the constant temperature equipment shown in the display and monitor the fill level during filling.
8. Fill the constant temperature equipment with the pressure pump.
9. Once the desired fill level has been reached, close the tap on the filling nozzle. Switch off the pressure pump. Remove the pressure pump and screw on the sealing cap.
10. You should degas the heat transfer liquid after filling.



For Integral XT: Refilling the heat transfer liquid

Heat transfer liquid should be pumped into the application

1. If the device is partially filled, *Fill mode* can be manually started.
→ *Main menu* → *Fill mode* → *Start filling*.
2. Select the → *Fill mode* → *Start filling* → *Start pump* menu items.
You might have to [delete the alarm] in the [Fill mode] menu.
 - ▶ Heat transfer liquid is pumped through the external consuming unit.

3. Fill up with heat transfer liquid until the desired liquid level is reached. In the meantime, let the pump run.
The cooling unit is switched off. The outflow temperature can rise above the set temperature due to the heat input of the pump.
4. Press [Stop filling] to exit filling mode and stop the pump.
With [Stop pump], the pump is stopped.



When refilling during operation, it is not necessary to start the fill mode. If necessary, switch the unit to standby mode. To do so, press the [STOP] softkey.



Only for Integral XT

If [Fill mode] is active, the device does not heat or cool. You can only start the device after you end [Fill mode].

5.6 Degas heat transfer liquid (low boiling point expulsion)

This section is relevant for:

- Integral XT devices

Please note:

- Degas slowly and carefully, especially in the case of liquids with a high proportion of low boilers.
- There must be no gas cushions in the consumer system. Check this by reducing the pump power by one or two stages. The level indication of the device may not rise.
- To extend the temperature range of the heat transfer liquid used, nitrogen overlay in the expansion vessel is recommended.
- Ventilate the installation site. Vapors which are hazardous to health may be produced.



DANGER!
Hot heat transfer liquid in the expansion vessel

Fire

- Degas with the degas mode.

Degas mode description

- Personnel: ■ Specialized personnel
- Protective equipment: ■ Safety glasses
 ■ Protective gloves
 ■ Protective work clothing

Principle: During degassing, the heat transfer liquid is boiling. Gas can escape at various points in the circuit. For example, at the heater or at a throttle point.

The Integral XT device is equipped with a gravity separator upstream of the pump, through which the gas passes into the expansion vessel.

Degassing

We recommend an inert gas blanket for faster degassing of the IN 2560 XTW ↗ Chapter 6.26 “Operation with inert gas blanket” on page 134.

You can also use compressed air instead of an inert gas for degassing the heat transfer liquid.

The following parameters are set automatically in degas mode:

- The pump is set to level 2 (in IN 2560 XTW/PW: pump level 4). Only change the pump level when it is necessary.
Caution when selecting the pump level in connection with pressure-sensitive consumers (e.g. glass apparatus)!
- The heating output is reduced to about 50% of the total heating output of the process thermostat.
- The cooling unit is switched off. The outflow temperature can rise above the set temperature due to the heat input of the pump.
- The pump switches briefly off and on again approximately every 45 seconds.
- Do not use pressure control. Note the maximum pressure!

1. After filling and venting, heat the heat transfer liquid up to 20 K above the later maximum working temperature.

Enter the new set temperature and confirm it.



- Note the maximum working temperature range of the heat transfer liquid.
- Note the maximum working temperature range of the connected consumer.
- An inert gas blanket can be used to accelerate degassing in the IN 2560 XTW.

See ↗ Chapter 6.26 “Operation with inert gas blanket” on page 134.

2. Start degas mode.

In the menu, select → *Degas mode* → *Start degas mode*.

- ▶ Degassing starts.

In order to facilitate the removal of the low boilers during degassing, it may be useful to open the tank cover so that the steam escapes more easily (if necessary, use air extraction). In this operating status, constantly check the device; make sure to keep ignition sources away from the filling opening and protect the operating personnel from splashes (e.g. place the cover diagonally on the filling opening). Appropriate protective equipment or protective clothing must be worn. After the end of degassing, close the filling opening again with the tank cover.

3. The end of degassing is reached when the outflow temperature has approached the set temperature (< 10 K) and does not continue to rise.

The end of degassing is also reached when the outflow temperature has exceeded the set temperature due to self-heating.

4. End the degas mode with → *Degas mode* → *Stop degas mode*.

- ▶ The device is in standby. All parameters described above are retained with their current settings.

Automatic degassing

If necessary, the device carries out the degassing automatically. If the device detects gas in the hydraulic system, the heating and cooling output is first reduced or temporarily switched off completely. If the pump pressure drops sharply (a clear sign of degassing), the pump speed is limited and the pump may be switched off briefly. When the automatic degassing is finished, the device resumes its operation automatically.

5.7 Setting the flow rate of the heat transfer liquid



CAUTION!
Bursting of the external application due to overpressure

Scalding, frostbite, impacts

- For applications with a maximum permissible working pressure that is less than the maximum pressure of the pump, use a pressure relief device for protection. This pressure relief device must be installed in the outflow to the application.
- Set the maximum pump pressure as per your application.

Setting flow rate for Integral T

This section is relevant for:

- Integral T devices



Before switching on, turn the bypass control knob counterclockwise to the fully open position.

- Personnel: ■ Operating personnel
- Protective equipment: ■ Safety glasses
 ■ Protective gloves
 ■ Protective work clothing

In the Integral T devices, the flow rate is set via the bypass on the right-hand side of the device. The bypass enables operation with a pressure-sensitive application.

1. To increase the flow rate and thus the pressure in the consumer, turn the bypass adjusting wheel clockwise until the desired (< permissible) pressure for the external consumer is reached.



Observe the changing display of [pump pressure] in the display.

To display the pump pressure, select the menu items → Pump → Pump pressure.

The current pressure of the pump in the outflow is displayed. No settings can be made here.

Setting pump level for Integral XT

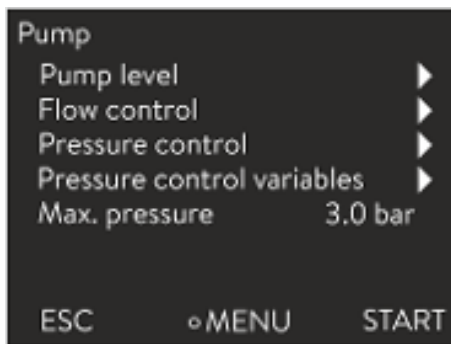

Fig. 38: Integral XT Pump menu

This section is relevant for:

- Integral XT devices

The pump of the device can be adjusted by means of several pump levels. This optimizes the flow rate and discharge pressure, noise generation and mechanical heat input.



If you have connected a pressure-sensitive application, you must use the settings [Set pump pressure] (→ Pump → Pressure control → Set pump press.) and [Max. pressure] in the Pump menu.

Entries in the Pump menu

- Pump level
- Through-flow control
 - The Flow control menu is only displayed if an MID flow controller has been connected.
- Pressure control with entry window for the set pump pressure
 - As an alternative to the 8 pump power stages, operation with pressure control is provided. The device then regulates to the set pressure and enables a careful supply of pressure-sensitive consumers.
 - You enter a value in this entry window when you have connected a pressure-sensitive consumer. This value in the bar unit depends on the sensitivity of your consumer. If you enter a setpoint of 0 bar, the pressure control is switched off.
- Pressure control variables

No settings can be made here.

 - Pump pressure: Displays the current pressure of the pump in the outflow.
 - Outfl. Press. FC

Displays the pressure currently measured at the output of the flow controller. The menu is only displayed if a flow controller has been connected.
 - Extern Ethernet and Extern analog: Displays the externally measured pressure supplied via the interface.
- Max. pressure
 - This entry serves to protect your application. Set the maximum pressure to a level which cannot damage your connected application. The set pressure must be lower than the maximum pressure. If the maximum pressure you entered is exceeded, the device switches off. Pump, heater and cooling unit are switched off.
- Auxiliary pump
 - The menu is only displayed if an auxiliary pump has been connected.

Setting the pump level

- Personnel: ■ Operating personnel
- Protective equipment: ■ Safety glasses
■ Protective gloves
■ Protective work clothing



Only pump levels 4-8 can be set for IN 2560 PW and IN 2560 PW.

1. Press the Enter key to open the menu.
2. Select the menu items → *Pump* → *Pump Level*.
 - ▶ The pump levels 1 to 8 are displayed. The currently active pump level is displayed inverted.
3. Select one of the pump levels displayed.
 - ▶ The selected pump level is activated automatically. It does not have to be activated separately.
4. With the [ESC] softkey, you return to the home window, or, with the left arrow key [*<*], you return to the Pump menu.

6 Operation

6.1 General warning



DANGER!
Hot heat transfer liquid in the expansion vessel

Fire

- Keep the cover of the expansion vessel closed during operation.



DANGER!
Risk of hot heat transfer liquid overflowing

Fire

- A connecting hose with a collecting vessel must be attached to the overflow.
- The collecting vessel and connecting hose must be designed to withstand the maximum temperature of the heat transfer liquid.
- Avoid ignition sources in the vicinity of the collecting vessel.



WARNING!
Splashing heat transfer liquid

Eye damage

- Always wear suitable safety glasses when working on the device.



WARNING!
Boiling heat transfer liquid escaping from the filling nozzle

Chemical and heat burns

- Never replenish hot heat transfer liquid with other fluids.



WARNING!
Overheating of the heat transfer liquid

Fire

- The heat transfer liquid used in the device must be set in the menu of the device.



WARNING!
Malfunctions on the overtemperature protection or low-level protection are not detected

Burns, scalding, fire

- Check the Tmax function and low-level protection on a regular basis.



WARNING!
Risk of refrigerant circuit bursting from excessive ambient temperatures while device is inoperative

Impacts, cutting, device damage

- Observe the permitted storage and operating temperatures.



CAUTION!
Touching hot/cold equipment parts and accessories

Hot and cold burns

- Never touch parts that are labeled with the warning symbol "Hot".



CAUTION!
Automatic device start with the timer

Scalding, cold burns, injury

- Before using the timer, ensure that all preparatory measures for intended use have been implemented!



NOTICE!
Risk of refrigerant escaping from cooling water circuit

Device damage

- Before decommissioning the device or if there is a risk of freezing, drain the cooling water circuit of the cooling unit using compressed air or an industrial vacuum cleaner (watertight). Blow compressed air through the circuit.

The following information is only relevant for the Integral T device:



CAUTION!
Risk of external consumer bursting

Scalding, cold burns

- Adjust the pump pressure with the bypass.

The following information is only relevant for the Integral XT device:

- You can increase or reduce the pump pressure via the pump levels.
- You can limit the pump pressure via the pressure control.
- For pressure-sensitive consumers (e.g. glass apparatus) with a maximum permissible working pressure below the maximum pressure of the pump (with Integral T pressure 3.5 bar, with Integral XT pressure 7.0 bar), the hoses of the consumer must be laid in such a way that kinking or squeezing is not possible. In addition, a separate safety pressure relief valve must be installed to protect against operating errors.
- To ensure temperature control at high loads (> 70 % cooling), a sufficiently high flow rate (at least pump level 4) must be ensured, especially at viscosities above 50 mm²/s. At least pump level 6 must be set for high-performance devices such as the Integral IN 2560 XTW and IN 2560 PW.
- The device should preferentially be operated at a higher pump level (at least pump level 4, the higher the better). If the pressure in the outflow becomes too high for the application, open the internal bypass of the constant temperature equipment.
- The error message "Evaporator frozen" and/or strongly fluctuating temperatures indicate that the flow rate in the device is too low (see also ↪ Chapter 10.3 "Troubleshooting" on page 153).
- If the viscosity of non-LAUDA heat transfer liquids rises above 50 mm²/s within the desired working temperature range (e.g. glycol-water mixture below -25 °C), you must enter the viscosity data of this heat transfer liquid in the constant temperature equipment (see also ↪ Further information on page 71). LAUDA Kryo 30 can be selected as an alternative when using a glycol-water mixture as the heat transfer liquid.
- If a low flow rate is required at high load, LAUDA recommends using the MID 80 flow controller (LAUDA catalog number L003217) for electrically conductive heat transfer liquids. The flow controller ensures that sufficient flow in the constant temperature equipment is guaranteed via its internal electronic bypass.

Please note:

- The device may only be moved after it has been drained. The device must be taken out of operation to do this.

6.2 Operating modes

The device supports two operating modes.

- In *Operation* mode, the components of the device are operational.
- In *Standby* mode, all device component are switched off. Power is only supplied to the display on the device. This operating mode is suitable for adjusting multiple settings, for example.



A program that has been started is paused in Standby mode. After activating Operation mode, the program must be resumed again manually.

6.3 Menu structure

Note: Depending on the device type or equipment, not all menu items may be displayed!

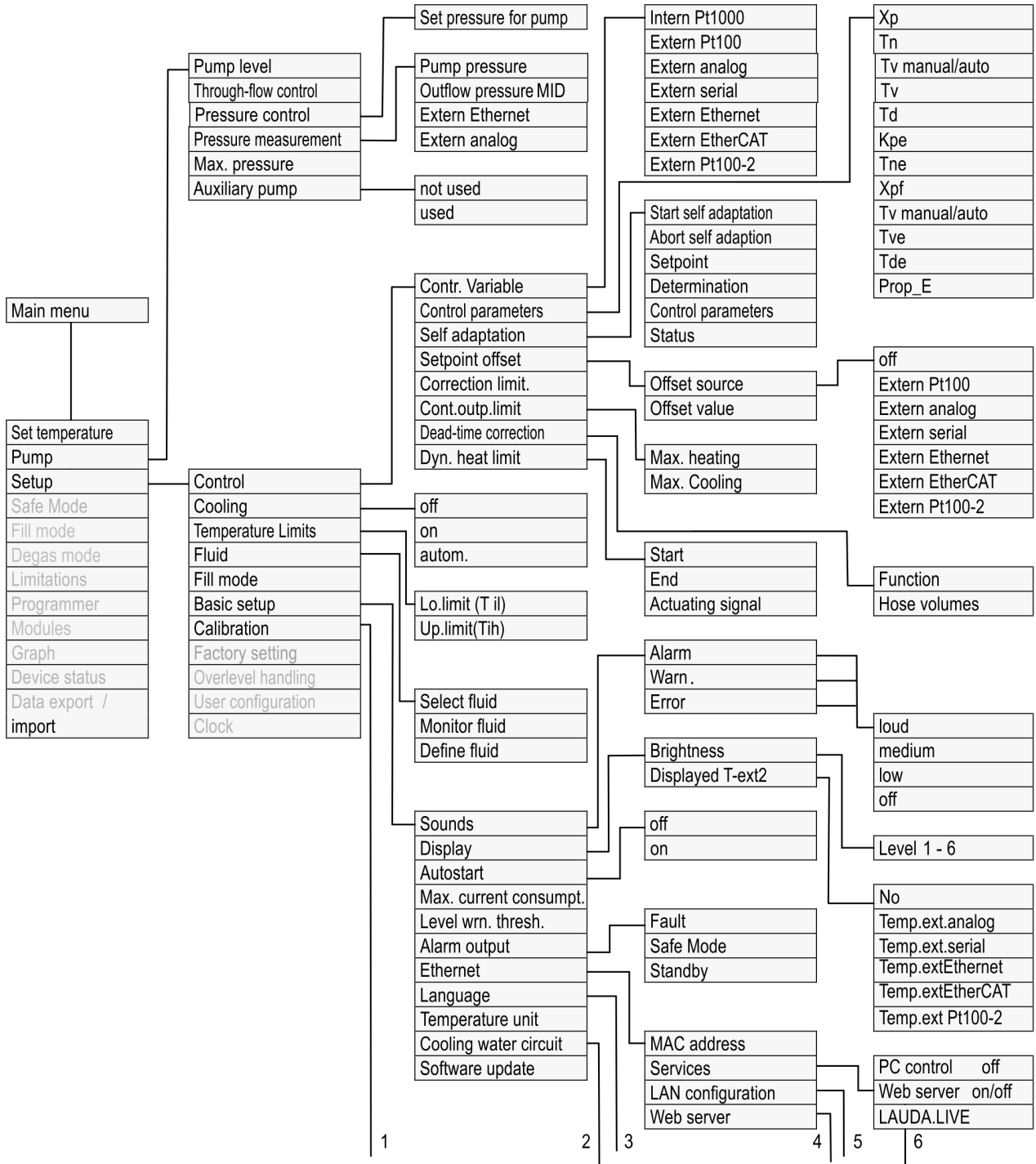

Fig. 39: Menu, Part 1

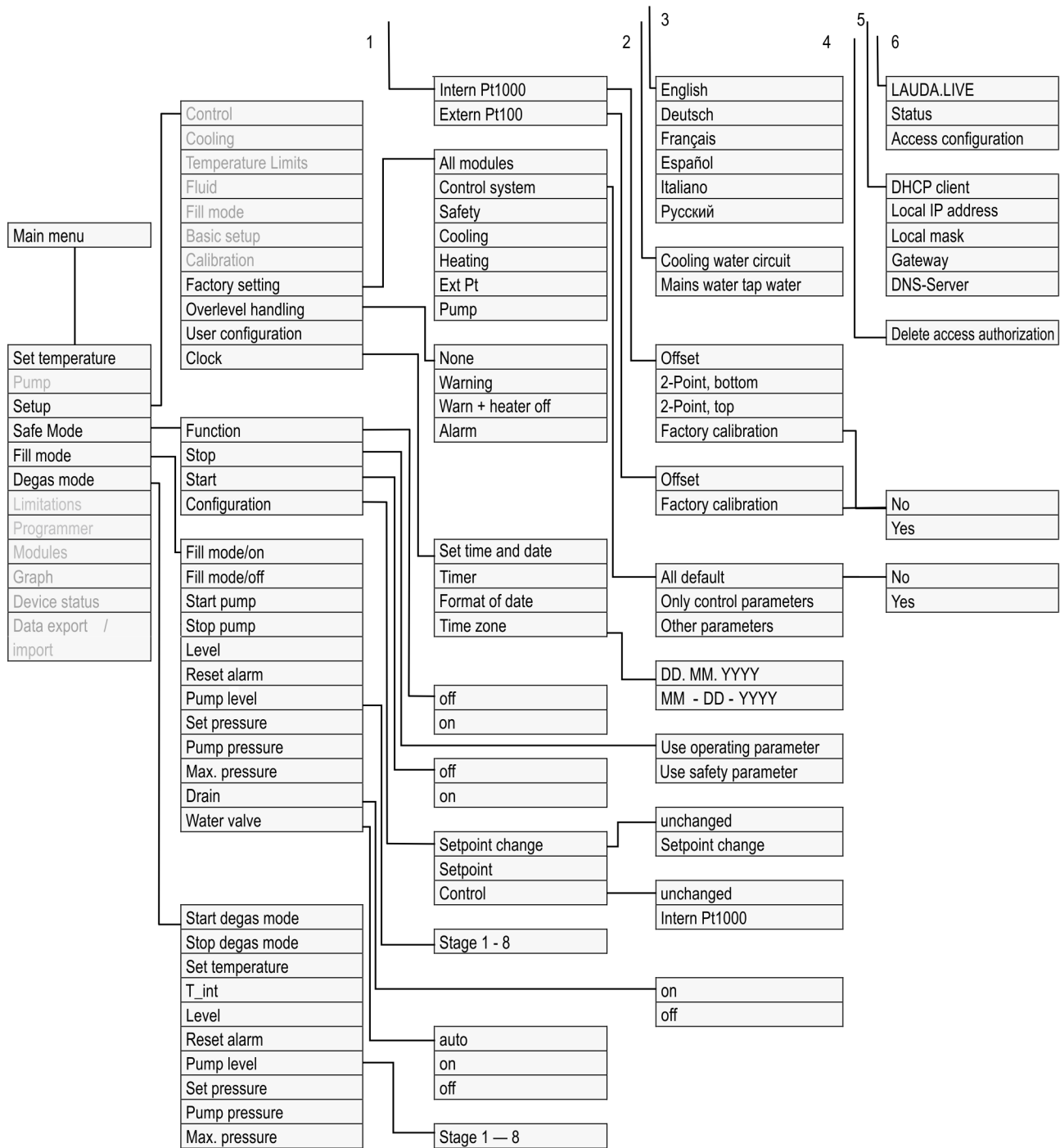

Fig. 40: Menu, Part 2 continuation from previous page

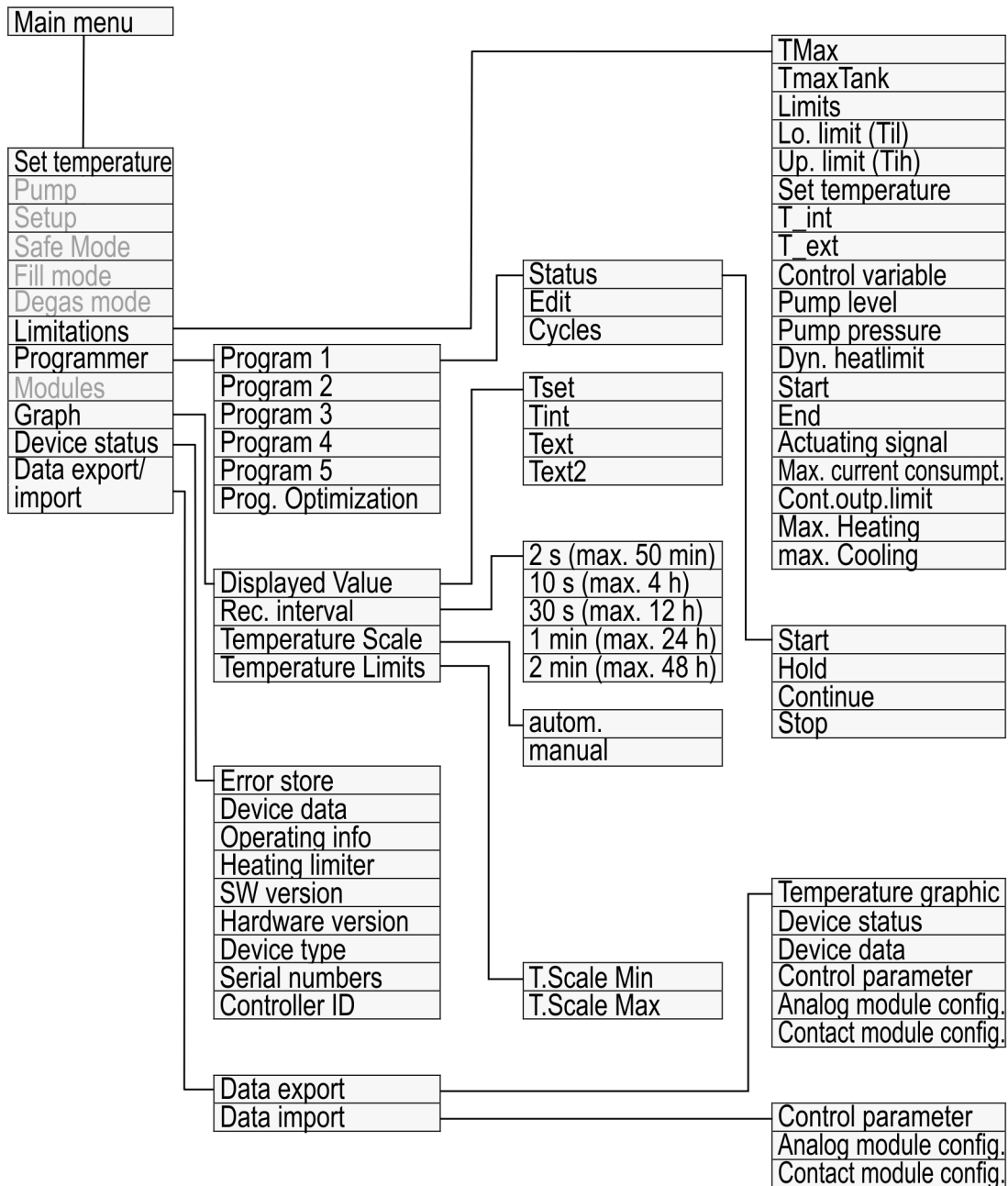

Fig. 41: Menu, Part 3, continuation from previous page

6.4 Setting Tmax



WARNING!

Overheating of heat transfer liquid due to incorrect entry of overtemperature switch-off point T_{\max} for the hydraulic circuit

Fire

- Set the overtemperature switch-off point for the hydraulic circuit to 5 K above the upper limit of the temperature range for your application. But not above the upper limit of the working temperature range of the heat transfer liquid.

The following information is only relevant for the Integral T device:



WARNING!

Overheating of heat transfer liquid due to incorrect entry of overtemperature switch-off point T_{\max} for the hydraulic circuit

Fire

- In the menu of the device, set the heat transfer liquid used in the device. Set the overtemperature switch-off point below the flash point of the heat transfer liquid.

The following information is only relevant for the Integral XT device:



WARNING!

Overheating of heat transfer liquid due to incorrect entry of overtemperature switch-off point $T_{\max\text{Tank}}$ for the expansion vessel

Fire

- In the menu of the device, set the heat transfer liquid used in the device. Set the overtemperature switch-off point $T_{\max\text{Tank}}$ below the flash point of the heat transfer liquid.

Personnel: Specialized personnel

The limits for the T_{max} values (Integral T and XT) and $T_{maxTank}$ values (Only Integral XT) are set automatically, as soon as the heat transfer liquid is selected in the device menu.

Therefore the value ranges of T_{max} and $T_{maxTank}$ to be set are limited by the heat transfer liquid. You can reduce these values of T_{max} and $T_{maxTank}$, but not set them higher than the specified limits.



Fig. 42: Display Tmax



Fig. 43: Enter new Tmax/Tank

1. Press and hold down the T_{max} key.
 - ▶ The values T_{max} and $T_{maxTank}$ appear on the display.
2. With the arrow keys select one of the two T_{max} values, while keeping the T_{max} key pressed down.
3. Press the Enter key.
 - ▶ The entry window (Fig. 43) appears. The cursor flashes under the T_{max} value or $T_{maxTank}$ value.

4. Change the value with the arrow keys.



If you release the T_{max} key, the process is aborted and $T_{max/Tank}$ was not changed.

5. Press [OK] to confirm the new value.
6. Press [ANW] softkey to confirm the new value.
 - ▶ The new value is active.

6.5 Set the setpoint offset

It is possible to apply an offset value to the temperature measured by an external temperature probe and then process this temperature as a target value. The setpoint of the heat transfer liquid in the device can therefore be set, for example, to 15 K below the temperature in the consumer, measured by the external temperature probe.

Navigating to the settings

1. Press the [Enter key] to open the menu.
2. Select the menu items → Setup → Control → Setpoint offset.
3. Select one of the following options:
 - [Offset source] allows you to select the source used to measure the offset.
 - [Diff. set/actual value] allows you to enter the value for the setpoint offset.

Entering the offset value

1. Select the [Diff. set/actual] button in the setpoint offset menu.
 - ▶ The entry window appears. An offset value can be entered within the limits displayed.
2. Enter the setpoint offset.
3. Press the [Enter key] to confirm.
4. The software returns to the previous Setpoint offset menu.

Activating an offset source

You can activate or deactivate the value entered for the setpoint offset of a corresponding source using the options in the [Offset source] menu. [External Pt100], for example, allows you to activate the setpoint offset for the external temperature probe.

1. Select the [Offset source] button in the Setpoint offset menu.
2. Select one of the following options:
 - Select [Off] to deactivate the offset source.
Activate an offset source from the remaining options:
 - [Extern Pt100]
 - [Extern analog]
 - [Extern serial]
 - [Extern USB]
 - [Extern Ethernet]
 - [Extern EtherCAT]
 - [Extern Pt100-2]
3. Press the [Enter key] to confirm.
4. Press the [ESC] softkey to switch to the home window.

6.6 Limiting heating and cooling

The maximum heating power or max. cooling capacity can be limited using the controller output limit. The limit is set as a percentage of the maximum value.

The controller output limit for the heating output is designed to prevent excessive temperatures on the surface of the heater. Excessive heater temperatures may degrade the heat transfer liquid.

1. Press the [Enter key] to open the menu.
2. Select the menu items → Setup → Control → Cont.outp.limit.
3. Select [Max. heating] and press [OK] to confirm.
 - ▶ An entry window appears. The controller output limit can be set to a value within the limits displayed.
4. Change the value accordingly.
5. Press the [OK] button to return to the previous screen with the new setting configured.
 - ▶ The new setting is active.

Automatic heat limit for smaller pump power

In the Integral XT the heat output is increasingly reduced if the pump power falls below 150 W (pump level < 4). This measure protects the heat transfer liquid from overheating on the heater surface and thus prevents premature aging of the heat transfer liquid.

6.7 Dead-time correction

The dead-time correction intervenes in the temperature control so that a stable temperature control can be achieved even with very large dead times. Use the dead-time correction if you have to operate the application with long hoses (>> 1 m) at very low flow rates (< 5 l/min).



The dead-time correction is only available if you use a flow controller (MID) and the flow controller can measure the flow of the heat transfer liquid.

The dead-time correction is only available for external control and has no effect on internal control.

Setup

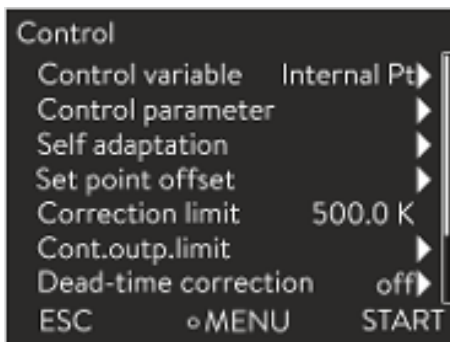

Fig. 44: Control menu

Proceed as follows to use the dead-time correction:

1. Press the [Enter key] to open the menu.
2. Select the menu items → Setup → Control → Dead-time correction.
3. Enter the volume of the hose used.



This volume can be mathematically determined just from the hose length (measured up to the temperature sensor to which is regulated) and the cross-sectional area of the hose.

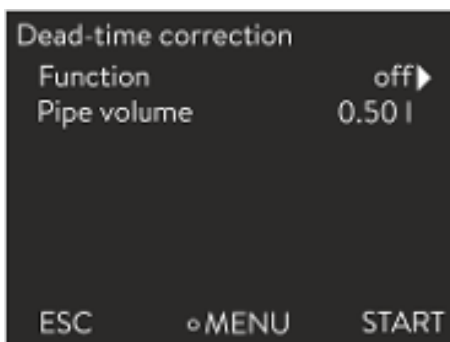

Fig. 45: Dead-time correction menu

4. Activate the dead-time correction with [Function on].



The dead-time correction means that the control system reacts much more quickly and that different control parameters can be set than in the case of normal external control as a result of the principle. In particular, significantly shorter reset times can be set for use of the dead-time correction.

The control parameters should be customized to the respective application when using the dead-time correction. On the whole, this results in significantly better control action in typical applications.

6.8 Dynamic heatlimiter

This section is relevant for:

- Integral XT devices

With the dynamic heat limiter, you limit the heating output of the device. At low flow rates at the heaters, there is a risk that the heat transfer liquid will overheat locally. This can lead to premature aging, oil cracking with silicone oils (depolymerization) or boiling.

Example

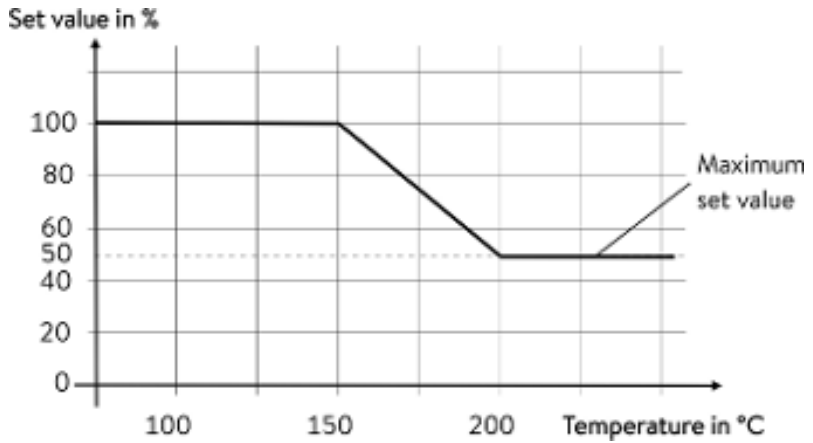

Fig. 46: Actuating signal

Start - 150 °C
 End - 200 °C
 Actuating signal - 50 %

Personnel: Operating personnel

1. Press the Enter key to open the menu.
2. Select the menu items → Setup → Control → Dynamic heat limit.
 - ▶ The submenu opens.
3. Enter your values and press the Enter key to confirm.

Menu items	Description
Start	You use the values for Start and End to specify a temperature range, in which the power of the heater is linearly limited to the entered value of the actuating signal. The heater works at reduced power above the entered end temperature ([End]). The heater works at full power below the entered start temperature ([Start]).
End	
Actuating signal	You enter the value for limitation of the heating output in percent here.

▶ The dynamic heatlimiter is active.

6.9 Cooling

The cooling unit of the devices is operated in the standard setting [autom.]. Depending on the temperature and operating status, the cooling unit is automatically switched on or off. You can switch the cooling unit on or off permanently via the menu. In the case of sensitive control processes, control fluctuations can be prevented by automatically switching the cooling unit on or off.



Fig. 47: Configuring cooling

1. Press the Enter key to open the menu.
2. Select the menu items → *Setup* → *Cooling*.
3. Select one of the following options:
 - With the [autom.] setting, the cooling unit is switched automatically. When cooling capacity is required, the cooling unit switches on.
 - With [off], the cooling unit remains switched off.
 - With [on], the cooling unit cools permanently.
4. Press [OK] to confirm the selection.

6.10 Setting temperature limits Tih and Til

This function is used to set temperature limits Tih and Til. The temperature limits limit the set temperature. A warning is issued if the internal actual temperature is outside the temperature limits. These temperature limits should reflect the limits of your application. A tolerance of 2 K should also be added to the upper and lower temperature limits to compensate for overshooting by the control, in particular external controls. The working temperature range of the heat transfer liquid must also be taken into consideration when defining temperature limits.

Setting Tih and Til

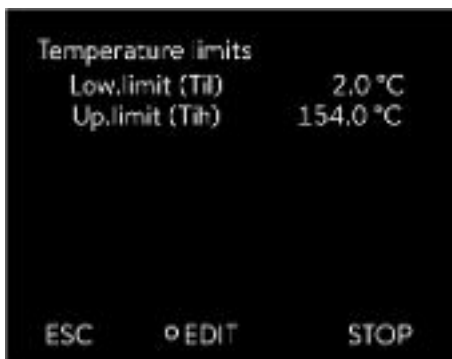



Fig. 48: Define temperature limits

1. Press the Enter key to open the menu.
2. Select the menu items → *Setup* → *Temperature limits* → *Lo.limit (Til)* or → *Up.limit (Tih)*.
 - ▶ The entry window appears. The cursor flashes under the value. The upper and lower temperature range is displayed.
3. Change the value with the arrow keys.

 *By pressing the [ESC] key, you return to the higher-level menu without making any changes.*
4. Press the Enter [OK] key.
 - ▶ The value is accepted.

6.11 Lock and release operating buttons

The operating buttons can be locked in order to protect the device when using a process control system or against unauthorized access.

Lock the operating button

Personnel: Operating personnel

1. Switch to the main menu.
2. Press and hold down the [input button].
3. Press and hold down the [Down] arrow button within 4 seconds.
4. Hold down both buttons for 4 seconds.
 - ▶ In the display the descriptions of the buttons are replaced by [---].
The entry function is now locked.

Release operating buttons

Personnel: Operating personnel

1. Press and hold down the input button.
2. Press and hold down the [Down] arrow button within 4 seconds.
3. Hold down both buttons for 4 seconds.
 - ▶ In the display the descriptions of the buttons show up again.
The device can be operated again.

6.12 Basic settings

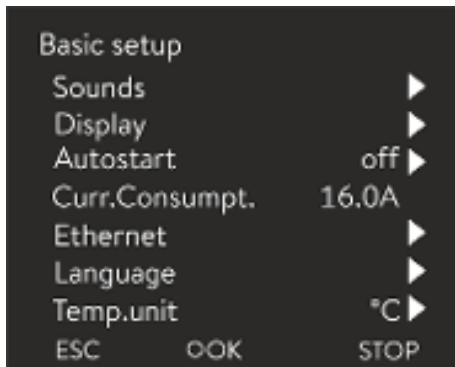

Fig. 49: Basic settings menu

Personnel: Operating personnel

1. Press the Enter key to open the menu.
2. Select the menu items → Setup → Basic setup.

The basic settings are described on the following pages.

Adjusting the volume of the sounds

The device indicates alarms, warnings and errors both visually and acoustically.

In the menu, you can adjust the volume of the sounds for:

- Alarm
- Warning
- Error

The volume settings are:

- loud
- medium

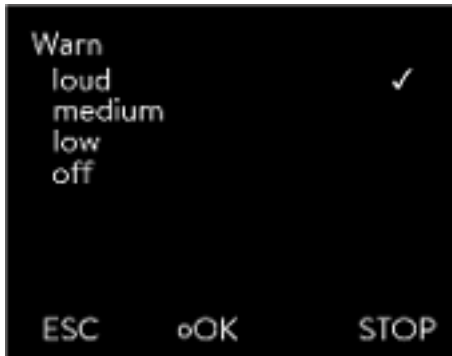

Fig. 50: Adjusting volume

Set the brightness of the display



Fig. 51: Adjusting brightness

Displayed temperatures in the display

Automatic start after power failure

- low
- off

1. In the Basic setup menu select the menu item → *Sounds*.
 - ▶ A list containing the sounds opens.
2. Select the sound that you wish to change using the arrow keys.
3. Press the Enter key to confirm your selection.
 - ▶ A list containing the volume settings opens.
4. Select a volume setting using the arrow keys.
5. Press the Enter key to confirm your selection.
 - ▶ The new setting is active.

The display brightness can be set manually.

1. In the Basic setup menu select the menu item *Display* → *Brightness*.
 - ▶ A list containing the settings opens.
2. The following options are available in the window:
 - You can select the brightness manually with entries [Level 1 - 6]. The brightness intensifies from [Level 1].
 - ▶ The new setting is valid with immediate effect.

In the [Displayed T-ext2] menu you can select via which interface a **second** external temperature value is read into your device. The newly selected temperature value is displayed in the home window and in the graphic window.

1. In the Basic setup menu select the menu item → *Display* → *Displayed T-ext2*.
 - ▶ A list containing the settings opens.
2. Select the external temperature with the arrow keys, which you would also like to be displayed.
 - ▶ The measuring channels are displayed which are installed in the device.
3. Press the Enter key to confirm your selection.
 - ▶ The new setting is active.

After a power failure and restoration of the power supply, the device **does not** resume operation (default setting). However, you can set the device to automatically resume operation after the power is restored.

1. In the [Basic setup] menu, select the menu item → *Autostart*.
 - ▶ A list containing the settings opens.

2. Select one of the following options:
 - With [Off], the device is set to standby operating mode after a power failure and when the power supply is restored.
 - With [On], the device is set automatically continue after a power failure and when the power supply is restored.



Automatic running of the device may result in unattended operation.

3. Press the Enter key to confirm your selection.
 - ▶ The new setting is active.

Limiting the current consumption

The fuse on the installation side must at least correspond to the maximum current consumption of the device (see rating label). If the mains fuse is lower, you must reduce the maximum current consumption of the device. The heating output will be reduced accordingly. When setting the current consumption, consider whether other loads may be connected to a fuse together with your device.

Personnel: ■ Specialized personnel

1. In the [Basic setup] menu select the menu item → *Curr. Limit*.
 - ▶ An entry window opens for a numerical value. The cursor flashes under the numerical value. The upper and lower entry range is displayed.
2. Change the value with the arrow keys.



By pressing the [ESC] key, you return to the [Basic setup] menu without making any changes.

3. Press the [OK] to confirm the new value.
 - ▶ The new value is active.



The reduction of the maximum current consumption of the device reduces the heating power and thus influences the control characteristics, where applicable.

Selecting the menu language

The menu languages English, German, French, Spanish, and Italian are available for the device display.



Fig. 52: Select language

Select temperature unit

1. In the [Basic setup] menu select the menu item → *Language*.
 - ▶ A list containing the languages opens.
2. Select your language using the arrow keys.
3. Press the Enter key to confirm your selection.
 - ▶ The new setting is valid with immediate effect.

In the [Temp. unit] menu you can select in which unit the temperature value is displayed. In general, this setting is valid for all windows in the display.

1. In the [Basic setup] menu select the menu item → *Temp. unit*.
 - ▶ A list of the options opens.
2. Select one of the following options:
 - With [°C] all temperatures are displayed in *°Celsius*.
 - With [°F] all temperatures are displayed in *°Fahrenheit*.
3. Press the Enter key to confirm your selection.
 - ▶ The new setting is valid with immediate effect.

6.13 Calibrating the temperature probe



A calibrated reference thermometer with the desired level of accuracy is necessary. Otherwise you should not change the calibration of your constant temperature equipment.

If, when checking the temperature in a steady state, you discover a constant temperature deviation of T_{int} or T_{ext} from the reference thermometer, this can be equaled out via the *Calibration* menu point.

With the menu point *Offset* (1-point comparison), the characteristic of the temperature switch is adjusted in parallel by the input value.

With the menu point *2-point calibration* (2-point comparison), the characteristic of the temperature switch is adjusted and the slope of the characteristic is changed.



It is possible to change the temperature values T_{int} and T_{ext} within a range of ± 3 K respectively.

Offset

- For calibration, the reference thermometer must be installed in the outflow of the device according to the specifications on the calibration certificate.
- To measure the temperature, wait until the system is in a steady state.
- 1. Press the [Enter key] to open the menu.
- 2. Select the menu items → *Setup* → *Calibration* → *intern Pt1000* or → *extern Pt100* → *Offset*.
 - ▶ The entry window opens.
- 3. Enter the temperature value read from the reference thermometer into the entry window.
- 4. Press the [OK] to confirm the new value.
 - ▶ The new value has been accepted.

2-point calibration

- For calibration, the reference thermometer must be installed in the outflow of the device according to the specifications on the calibration certificate.
- The upper and lower temperature measurement points must be at least 40 K apart.
- To measure the temperature, wait until the system is in a steady state.
- 1. Set a low T_{set} setpoint on the device.
- 2. Wait until the setpoint and the temperature of the heat transfer liquid have equaled out.
- 3. Press the [Enter key] to open the menu.
- 4. Select the menu items → *Setup* → *Calibration* → *intern Pt1000* or → *extern Pt100* → *2-point lower*.
 - ▶ The entry window opens.
- 5. Enter the temperature value read from the reference thermometer into the entry window.
- 6. Press the [OK] to confirm the new value.
 - ▶ The lower value has been accepted.
- 7. Set a high T_{set} setpoint on the device.
- 8. Wait until the setpoint and the temperature of the heat transfer liquid have equaled out.
- 9. Select the menu item [2-point upper] in the *Calibration* menu.
 - ▶ The entry window opens.
- 10. Enter the temperature value read from the reference thermometer into the entry window.
- 11. Press the [OK] to confirm the new value.
 - ▶ The upper value has been accepted. 2-point calibration has been completed.

Restore factory calibration

Use this menu item to restore the calibration configured in the factory.

1. Press the [Enter key] to open the menu.
2. Select the menu items → *Setup* → *Calibration* → *intern Pt1000* or → *extern Pt100* → *Factory calibration*.
3. Select the option [yes].
4. Press [OK] to confirm the selection.
 - ▶ This deletes the customer's calibration and restores the calibration as it was configured in the factory.

6.14 Restore the factory setting

Navigate to the Factory setting menu

1. Press the Enter key to open the menu.
2. Select the menu items → *Setup* → *Factory setting*.

Reset all modules

With the menu [All modules], the software settings of all modules of the device are reset to factory settings.

Further down in the Factory setting menu you can select and reset individual modules.

Reset control system

In the [Control system] menu, you can reset your specific settings to factory settings.

- Reset all
- Only control parameters
- Other parameters

Reset in the [Reset all] menu:

- Control
 - Control variable
 - Control parameters
- Temperature limits
- Basic settings
 - Sounds
 - Display
 - Autostart: On
 - Current consumption
 - Language
- Calibration
- Graphic display
- Home window
- Operating mode (operation)

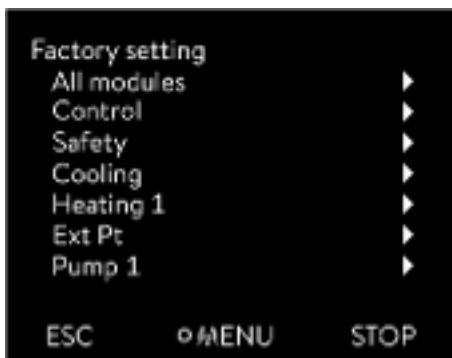

Fig. 53: Factory setting menu

Personnel: ■ Operating personnel

1. Select the [Reset all] menu item.
2. Select one of the following options:
 - By pressing the [no] key, you return to the higher-level menu without making any changes.
 - By pressing the [yes] key, the device is reset to factory settings when you confirm this action with the Enter key.
 - ▶ The complete device is reset to factory settings.

Select and reset individual control parameters

With the menu [Only control parameters] or [Other parameters], only the selected parameters are reset to factory settings.

Personnel: ■ Operating personnel

1. Select the [Other parameters] menu item.
2. Select one of the following options:
 - By pressing the [no] key, you return to the higher-level menu without making any changes.
 - By pressing the [yes] key, the device is reset to factory settings when you confirm this action with the Enter key.
 - ▶ The parameters are reset to factory settings.

6.15 Viewing the Device status

In the Device Status menu and its submenus, you can display lots of information and data about the device. No settings are possible in the whole Device Status menu.

1. Press the Enter key to open the menu.
2. Select the menu items → Setup → Device Status.
 - ▶ A submenu opens.
3. These menu items are available:
 - Error memory,
 - Display device data,
 - Display operating information,
 - Display heating limiter,
 - Display software version,
 - Display hardware version,
 - Display device type and
 - Display serial numbers.

Displaying the error memory

The device has an error memory for storing up to 140 warning, error and alarm messages that can be used to analyze errors.

1. Select the → *Errorstore* menu item in the Device status menu.
2. You can navigate through the list using the up and down arrow keys. The most recent message is in the top line.

The following information is displayed for each message:

- *No.* refers to consecutive numbers listed chronologically after the error occurs.
- The relevant module that triggered the message is displayed under *Source*.
- *Code* is the encoded description of the alarm, warning or error.
- *Type* specifies whether it is an alarm, warning or error.
- *Date* and *Time* display the time of the message.

The message marked above is explained in more detail at the bottom of the display.

Displaying device data

LAUDA Service uses this list for diagnostic purposes.

The device data is required for on-site service visits and telephone support.

1. Select the → *Device data* menu item in the Device Status menu.
 - ▶ Various current values of the device are displayed (e.g. temperatures).

Displaying operating information

The menu item *Operating info* shows how long or how often components of the device have been in use.

The service life of the components listed below is displayed in hours unless otherwise stated.

- Heat transfer liquid (fluid)
- Heating
- Pump (only appears for Integral XT)
- Pump 2 (only appears for Integral IN 1850 XTW, IN 2050 PW, IN 2560 XTW/PW)
- Compressor
- Compressor 2 (only appears for devices with cooling cascade)
- Compressor duty cycle
 - The number of switching cycles (ON - OFF) is indicated.
- Compressor 2 duty cycle (only appears for devices with cooling cascade)
 - The number of switching cycles (ON - OFF) is indicated.
- EEV 0 steps
 - EEV are the electronic injection valves with the numbers 0 to 6, the opening of the valve is indicated in number of steps.

Heating limiter

The submenu displays all current limits of the device. These limits have been set by the user in other menus or have been activated by the device software based on the device configuration.

- Pump
- Current consumption
- Dynamic heating output restriction

- Upper limit value (Tih)
- Degassing mode
- Fill mode
- Cont.outp.limit
- T_triac

Displaying software versions and hardware versions

The relevant versions of the installed software and hardware are required for on-site service visits and telephone support.

1. In the Device status menu select the menu item → *SW version* or → *Hardware version*.
 - ▶ The software versions installed on the device are displayed. If available, the software versions of any connected interface modules are also displayed. The hardware version is not displayed for all modules. In the case of older modules, no hardware version can be recorded by software and displayed. In such cases “---” is displayed.

Displaying the device type

The device type is displayed in the Device type menu item.

Displaying serial numbers

The serial numbers are required for on-site service visits and telephone support.

1. Select the → *Serial numbers* menu item in the Device Status menu.
 - ▶ The serial numbers of the device components are displayed.

6.16 Through-flow control of the internal heater

This section is relevant for:

- Integral XT devices



The bypass valve is used to ensure that there is sufficient flow through the heater in the device to prevent damage to the heat transfer liquid.

1. If the flow rate in the device is too low, a sound is heard for three seconds.
 - ▶ The heating switches off on all poles, the pump and the cooling unit are switched off.
2. In the display the message appears that the flow is too low.
3. Eliminate the cause.

If the reason for the low flow rate is the high flow resistance caused by the application, turn the adjusting wheel of the bypass valve counterclockwise. Turn the adjusting wheel so far until the required flow is reached.
4. Press the Enter key.

Also press the Enter key if the device was switched off in the fault state. Warnings disappear automatically when the cause is eliminated.

6.17 Programmer

6.17.1 Basic information



Fig. 54: Programmer

The programmer allows you to perform and save a temperature-time program. A program consists of several temperature-time segments. A segment contains information on the final temperature of the segment, the duration, the temperature tolerance, the pump level and the switch position (off/on) of the contact. Ramps, temperature jumps and temperature maintenance phases are possible.

The programmer of the constant temperature equipment has 5 programs. Together, these 5 programs share a total of 150 segments.

One program occupies at least one segment.

A maximum of 146 segments can be stored in one program.

- Ramp

A ramp is defined by the specified duration between the start and the end of the segment, and by the destination temperature, i.e. the temperature at the end of the segment.
- Temperature jump

If a time is not specified (time is equal to 0), the end temperature is reached as quickly as possible.
- Temperature maintenance phase

No temperature change (i.e. the temperatures at the start and end of a segment remain identical).
- Pump level off or 0
 - Integral T: Pump level [off] can be selected within a segment. As a result, the program ends when this segment is reached, even though other segments follow in the program. The status of the thermostat is set to "Standby". When the program is started, a message appears indicating that the program will end at this segment.
 - Integral XT: Pump level [---] (means pump is off) can be selected within a segment. As a result, the program ends when this segment is reached, even though other segments follow in the program. The status of the thermostat is set to "Standby". When the program is started, a message appears indicating that the program will end at this segment with pump level 0.
- Program optimization

Activating program optimization yields a very good control action in practice. With programs including both ramps and other types of segments, the actual temperature profile matches the target temperature profile more closely than programs without optimization. It reduces overshoots. There can only be increased undershooting at the ramp end if the control parameters are very unfavorable. Deactivate optimization in this case.

Tolerances that are too small will impair the control result. Work without tolerances where possible.
- Standby

If the device switches to standby while a program is running, the active program is automatically paused.

 1. Press the Enter key to open the menu.
 2. Select the → Programmer → Program X menu item.
 - ▶ The submenu opens in the selected program.



Fig. 55: Program 1

3. The following options are available:
 - [Status]
 - Select the option [Start] to start the program.
 - Once the program has started, you can press [Hold] to pause it.
 - A paused program can be continued by pressing [Continue].
 - Select the option [Stop] to end the program.
 - [Edit]
 - [Loops]
 - Here you enter the number of repetitions of the selected program.
4. Select the → Edit menu item.
 - ▶ The program appears on the display and you can now edit it.

You can stop the programmer by pressing the [STOP] softkey. After pressing the [START] softkey, the programmer continues to run in the previously selected mode (pause or active mode).



The programmer encoder can be controlled or modified using the timer.

Available settings

No.	Tend	hh	:mm	Tolerance
Start	30.00	---	---	0.1
1	50.00	0	20	0.0
2	50.00	0	20	0.0
3	70.00	0	20	0.1
4	60.00	0	30	0.0
5	30.00	0	0	0.0

Fig. 56: In program editor

Setting	Description
No.	Program segment number
Tend	End temperature that should be reached
hh	Time in hours (hh) by which the specified temperature should be reached
:mm	Time in minutes (: mm) by which the specified temperature should be reached
Tolerance	Tolerance defines how close the temperature should be to the set temperature before the next segment is processed. 0.0 means that there is no tolerance. This means that the program starts the next temperature after the preset time, even if the output temperature has not yet been reached.
Pump	In Integral T the pump is switched on or off. No pump levels can be set. In the Integral XT the pump level can be entered with which the segment is to be processed.
S1, S2, S3	The switching state (off or on) of a contact module (if installed) can be entered here. Contact modules are available as an accessory.

Examples of the functions of a contact

- Functions of the inputs
 - Set fault
 - Set standby
 - Control programmer
 - Control alternating operation (2 different set temperatures)
 - Regulate internal or external control
- Functions of the outputs
 - Signal various error states
 - Signal standby
 - Specify position with respect to a temperature window (inside or outside)
 - Specify programmer status
 - Signal refilling

Editing program examples

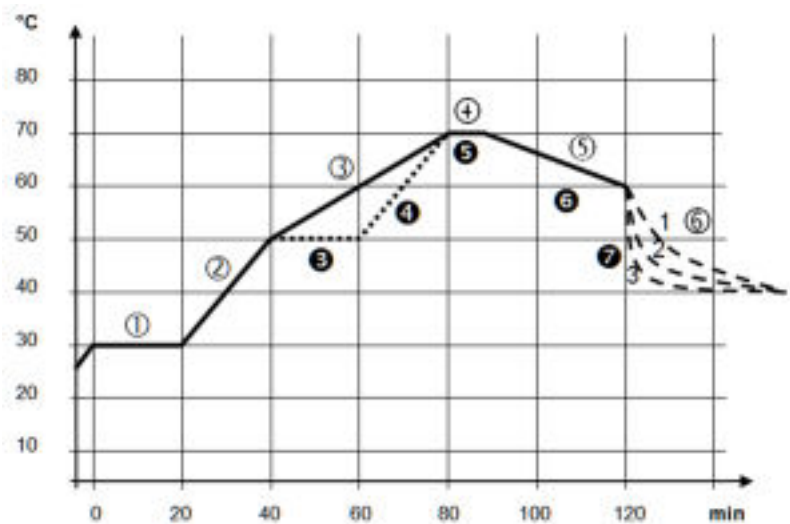

Fig. 57: Program example

The graph shows an example of a reprogrammed set temperature profile.

The cooling time in the graph varies depending on the device type, consumer and so on. In example segment number 2, 50 °C should be reached within 20 minutes.

The original values in the first table below (before) are represented by a solid line, while the values in the edited profile in the second table (after) are represented by a dashed line.

Start segment

Each program starts with the segment *Start*, which determines the temperature at which segment 1 continues the program. The temperature of the *Start* segment is reached as quickly as possible. It is not possible to specify a time limit for the *Start* segment. Without the *Start* segment, segment 1 would be different depending on the heat transfer liquid temperature at program start.

Table 34: Program example, before (—)

No.	Tend	hh	:mm	Tolerance	Pump	S1	S2	S3
Start	30.00	---	---	0.0	---	off	off	off
1	30.00	0	20	0.1	2	off	off	off
2	50.00	0	20	0.0	3	off	off	off
3	70.00	0	40	0.0	4	off	off	off
4	70.00	0	10	0.1	2	off	off	off
5	60.00	0	30	0.0	2	off	off	off
6	40.00	0	0	0.0	2	off	off	off

In the edited table, a new segment with the number 3 has been entered. The time and the pump level for segment 4 have also been modified. The tolerance and pump level for segment number 5 have been adapted.

Table 35: Program example, after (- - - dashed line, edited)

No.	Tend	hh	:mm	Tolerance	Pump	S1	S2	S3
Start	30.00	---	---	0.0	---	off	off	off
1	30.00	0	20	0.1	2	off	off	off
2	50.00	0	20	0.0	2	off	off	off
3	50.00	0	20	0.1	3	off	off	off
4	70.00	0	20	0.0	4	off	off	off
5	70.00	0	10	0.8	2	off	off	off
6	60.00	0	30	0.0	2	off	off	off
7	30.00	0	0	0.0	2	off	off	off



In the Integral T in the **Pump** column [off] or [on] can be entered.

Tolerance

Note the following and see Fig. 58:

- The Tolerance field ensures strict compliance with the residence time at a specific temperature, for example.
- The subsequent segment is only processed when the outflow temperature reaches the tolerance range (1) so the ramp in the second segment is delayed and only starts at 2, for example.

- Selecting a tolerance range that is too small can cause undesired delays. In extreme cases, it may not be possible to continue the program. The selected tolerance range should not be too small, **especially if the control is external**. A greater tolerance has been entered for segment 5 to guarantee adherence to the required time of 10 minutes, even with transient responses (3).
- A tolerance range should only be programmed for flat (slow) ramps, if appropriate. Steep ramps that come close to the maximum possible heating-up or cooling rates of the device may be severely delayed (4) if the tolerance range is too small (in segment 2 here).

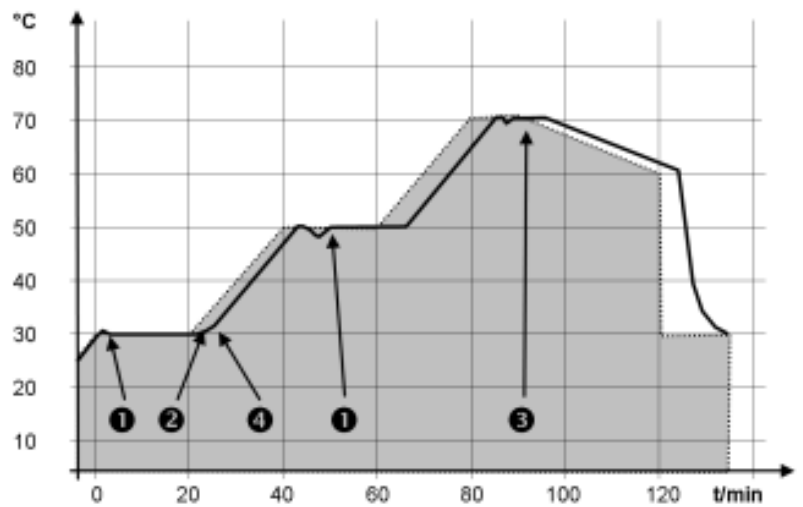

Fig. 58: Target/actual program process

The above graph of the edited process illustrates the possible delay of the actual temperature (solid line) in relation to the set temperature of the programmer (highlighted gray).

6.17.2 Set and process program

Please note:

- If a segment time > 999:59 h is included, this time must be distributed over several successive segments.

Start processing

No.	Tend	hh	:mm	Tolerance
Start	30.00	---	---	0.1
1	50.00	0	20	0.0
2	50.00	0	20	0.0
3	70.00	0	20	0.1
4	60.00	0	30	0.0
5	30.00	0	0	0.0

ESC ○ OK +/-

Fig. 59: Editing a program

1. Select the *Edit* menu item for the selected program.
 - ▶ You can edit the program.

Editing a program

Please note:

- If in the *hh* and *:mm* field the value "0" is entered, the temperature T_{end} will be started as quickly as possible.
- Changes to the pump level are entered in the respective segment (= program line).
- The default value of the contact module is *off*.

You have the following options in the selected program:

- By pressing the right arrow key 5 times you can display the columns Pump, S1, S2 and S3 of the program.
- Use the left arrow key to display the columns T_{end} , *hh*, *:mm* and Tolerance again.
- With the [up] and [down] arrow keys, you can navigate to the segments (lines) of a program.
- With the [OK] you select a value for editing.
- Use the [right] and [left] arrow keys to select individual digits of the value.
- With the [up] and [down] arrow keys, you can increase or reduce the selected digit.
- With the [ESC] softkey, you can deselect a selected value again.
- With the [OK] key, you confirm your change.
- You exit the program with the [ESC] softkey. The entered values are saved.

Add new segment

No.	T_{end}	hh	mm	Tolerance
Start	30,00	---	---	0,1
1	50,00	0	20	0,0
2	50,00	0	20	0,0
3	70,00	0	20	0,1
4	60,00	0	30	0,0
5	30,00	0	0	0,0

ESC ◯NEW DELETE

Fig. 60: Select program segment

Delete segment

1. Navigate to the segment under which the new segment should be added.
 2. In this segment, navigate to the column with the *No.*
 3. Press the [NEW] key.
 - ▶ A new segment is created.
1. Navigate to the segment that you want to delete.
 2. In this segment, navigate to the column with the *No.*
 3. Press the *DELETE* softkey.
 - ▶ The segment is deleted.

Editing a program currently running

Please note:

- No segments can be added or deleted in a currently running program.
 - In the running program, changes of the existing temperature values and segment durations are possible. The segment is continued as if the change had been effective since the beginning of the segment.
 - If the new segment time is shorter than the elapsed segment time, the program jumps to the next segment.
1. Select the *Edit* menu item for the running program.
 - ▶ You can edit the segments.

6.18 Set time, date, format and time zone

Set time format

The set time zone is used to convert between UTC (Universal Time Coordinated) and local time. The internal real-time clock runs in the Integral device according to UTC. The conversion then leads to the automatic changeover from standard time to daylight saving time and vice versa, since this is country-dependent. The leap years are independent of this setting as they are already included in the UTC. These entries with fixed dates for the coming decades are also included for countries that base their time zone offset on religious specifications.

UTC is also needed to obtain the time from the network because the time and date of NTP time servers are always supplied in UTC only. However, for this to work at all, the LAUDA device must be assigned an NTP time server via DHCP.

If DHCP is switched off and the IP address is permanently configured, automatic time tracking is not possible. (→ *Basic setup* → *Ethernet* → *LAN configuration* → *DHCP client*)

Only change the time/date if you have previously set the time zone. Otherwise, the local time may change due to the changed time zone offset when the time zone is changed.

Set time format

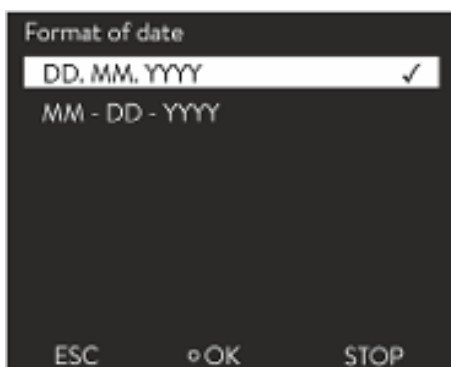

Fig. 61: Selecting options

Personnel: Operating personnel

You can display the date in two formats.

- Setting [DD.MM.YYYY] means days, month and year are displayed in this order (European).
 - Setting [MM - DD - YYYY] means month, day and year are displayed in this order (US English).
1. Press the Enter key to open the menu.
 2. Select the menu items → *Clock* → *Date format*.
 - ▶ A list containing the settings opens.
 3. The following options are available in the window:
 - Format [DD.MM.YYYY]
 - Format [MM - DD - YYYY]
 - ▶ The new setting is valid with immediate effect.

Set time and date

Personnel: Operating personnel

You can set the time and date.

1. Press the Enter key to open the menu.
2. Select the menu items → *Clock* → *Set time/date*.
 - ▶ The entry window opens.
3. Set the correct time and date.

Navigate with the four arrow keys.

 - You scroll to the corresponding point with the right and left arrow keys.
 - You change the numerical value with the up and down arrow keys.
4. Press the Enter key to confirm your selection.
 - ▶ The new setting is valid with immediate effect.

Set time zone

Personnel: Operating personnel

With the set time zone, the automatic changeover from daylight saving to standard time, correction of the date in a leap year, and so on takes place.

1. Press the Enter key to open the menu.
2. Select the menu items → *Clock* → *Time zone*.
 - ▶ The entry window opens.
3. Select your corresponding time zone.
4. Press the Enter key to confirm your selection.
 - ▶ The new setting is valid with immediate effect.



The device obtains the time and date from the network if it is operated in the network (Ethernet) with a time server. This means that the user only needs to set the time zone.

6.19 Self adaptation

The self adaptation function can be used to automatically find suitable control parameters for the respective application. Self adaptation can only be executed on a device with active cooling.

The self adaptation function performs a test run of the constant temperature equipment to determine the parameters. The device and application must be ready for operation.

For Integral XT, self adaptation is carried out with the currently set pump level. The best results can be expected at the highest pump levels. The pressure control of the pump can be used, but will worsen the result. If the current consumption of the device is significantly limited, the result deteriorates and the duration of the self adaptation increases.

The test run must be performed on a passive application. In other words, changes cannot be made to the application and exothermic or endothermic reactions may not occur during the test run.

The test run takes between 30 minutes and a maximum of 3 hours, depending on the application. During the run, the temperature of the heat transfer liquid deviates a maximum of ± 15 Kelvin from the defined setpoint. After completion of the test run, the newly determined values of the control parameters are accepted and stored in the [Control parameter] menu. The old control parameters are overwritten.

Start self adaptation

1. Press the [Enter key] to open the menu.
 2. Select the menu items \rightarrow Setup \rightarrow Control \rightarrow Self adaptation.
 - ▶ A submenu opens.
 3. Start self adaptation here:
 - [Start self adaptation]
 - The self adaptation run begins.
 - You can stop the self adaptation process prematurely by pressing [Cancel self adaptation].
 - Set point
 - Specify the temperature setpoint T_{set} here.
Take the maximum temperature fluctuations of up to maximum ± 15 Kelvin into consideration in the process.
 - Set [T_{ih}] and [T_{il}] accordingly.
 - Determination
 - With the *Only internal* command, you determine the internal control parameters.
 - With the *Internal and external* command, you determine both internal and external control parameters.
 - Control parameter
 - Here you can view the control parameters.
 - Status
 - Shows the current phase of the program for determining the parameters.
- WAIT - Self adaptation running
- END - Self adaptation ended
- SEND - Parameters are transmitted
- STOPPED - Self adaptation stopped

6.20 Control parameters

The thermal mass and the thermal connection of the application to the thermostat may make it necessary to adjust the control parameters.



Only modify the control parameters if you possess adequate knowledge of control system engineering.

6.20.1 Control basics

Definition

A brief explanation of terms

Actuating signal	- Initial value of the controller to compensate for the difference between the actual value and target value (control deviation).
PID controller	- The PID controller operates with extreme speed and precision and consists of a P, I and D-component.
Proportional range X_p	- The proportional range X_p indicates the temperature range within which the proportional component (P-component) of the controller represents 0 - 100 % of the maximum actuating signal. If the preset X_p is 10 K and the control deviation is 2 K, for example, the P-component is 20 % of the actuating signal. If the control deviation is 10 K or more, the P-component is 100 % of the actuating signal.
Adjustment time T_n	- The adjustment time is crucial for the I-component of the actuating signal. It specifies the interval at which an existing control deviation is integrated. The higher the T_n , the slower the control deviation is integrated and the more sluggish the control becomes. A small T_n makes the control more dynamic and eventually results in vibrations.
Hold-back time T_v	- The D-component of the actuating signal is formed from the hold-back time T_v . It influences the speed with which the actual value approaches the target value and counteracts the P-component and I-component. The greater the preset hold-back time T_v , the more intensively the output signal is attenuated. Rule of thumb: $T_v = T_n \times 0.75$.
Attenuation time T_d	- Attenuation time of the D-component. Rule of thumb: $T_d = T_v \times 0.15$.
Correction limitation	- Represents the maximum permitted deviation between the temperature at the external consumer and the temperature at the outflow.

Optimizing the hydraulic system

An important prerequisite for good control is a good connection between the application to be temperature-controlled and the constant temperature equipment.

- Use short hoses with a large cross section to reduce the flow resistance.
- Select a heat transfer liquid that is as thin as possible (viscosity below $30 \text{ mm}^2/\text{s}$) and with the highest possible heat capacity. Precedence list: Water, water-glycol mixture, oils, Fluorinert®.
- Set pump or bypass so that the volume flow of the heat transfer liquid is as high as possible.

Effects of viscosity on the heat transfer liquid

A control that is stable at low temperatures will usually be stable at high temperatures. Conversely, if a system is just about stable at high temperatures, it will most probably be unstable at lower temperatures, i.e. vibrate.

The viscosity of the heat transfer liquid changes drastically with the temperature. At low temperatures, liquids are more viscous. The control quality is therefore generally poorer at low temperatures. For this reason, the control setting should be towards the lower end of the temperature range.

If the temperature range of an application is -20 to 80 °C, for example, a control setting of -10 to 20 °C is most suitable.

Influence of control parameters on the control action

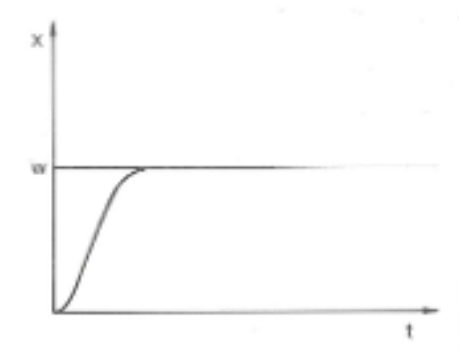
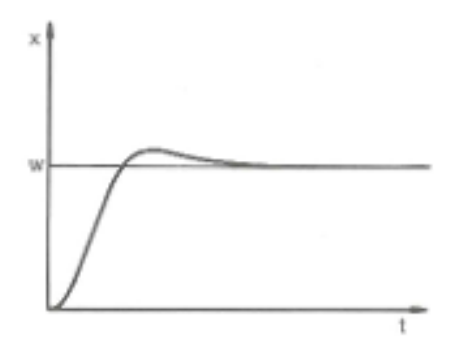
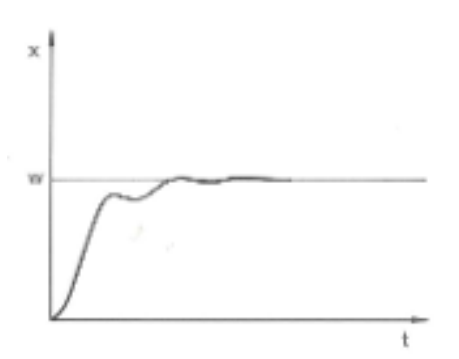

Fig. 62: Ideal setting



If the X_p parameter selected is too large, the actual value will reach the proportional range early and the P-component will be less than 100 % of the actuating signal. It takes longer to reach the target value and as a result, the simultaneously integrated I-component has more time to establish its actuating signal component. Once the target value is reached, the excessive addition of the I-component causes the value to overshoot the target value. If proportional range X_p is reduced, the P-component remains at 100 % for longer. Consequently, the actual value approaches the target value more quickly and the I-component has less time to integrate the system deviation. The overshoot is reduced.

Fig. 63: Control parameter X_p too large



If the proportional range selected is too small, the P-component of the actuating signal remains at 100 % for a long time. This value decreases even faster within the proportional range, i.e. the actuating signal decreases rapidly and the progress of the actual value towards the target value comes almost to a complete stop. The I-component, which only becomes effective now, causes the actual value to move slowly towards the target value.

Fig. 64: Control parameter X_p too small

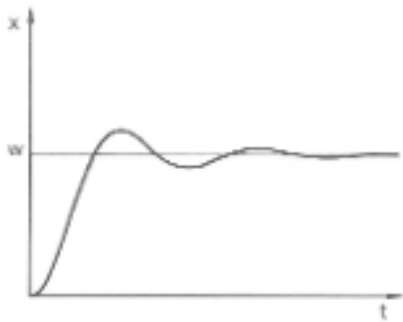

Fig. 65: Control parameters T_n and T_v too small

In the case shown here, the preset I component is too large (parameter T_n too small, T_n must be increased). The I-component integrates the control deviation until it becomes 0. If integration proceeds too rapidly, the actuating signal, i.e. the output signal of the controller, is too large. As a result, the actual value fluctuates (fading) around the target value. The hold-back time (parameter T_v) should be adapted using the formula: $T_v = T_n \times 0.75$ adapted.

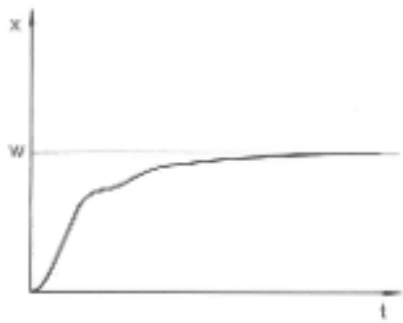

Fig. 66: Control parameters T_n and T_v too large

The actual value increases relatively sharply towards the specified target value. The proportional area settings seem to be correct. If the control deviation becomes smaller, the actual value approaches the target value much more slowly. The integration component (I-component) must compensate for the drastic reduction of the proportional component (P-component). In this case, the I component is integrated too slowly. The parameter T_n , which specifies the integration interval, must therefore be reduced. The hold-back time (parameter T_v) should be adapted using the formula: $T_v = T_n \times 0.75$.

6.20.2 Overview of internal control parameters

The internal control compares the set temperature with the outflow temperature and calculates the actuating signal, i.e. the measurement used for heating or cooling.

Table 36: The following control parameters can be adapted for internal control:

Characteristics	Designation	Unit
X_p	Proportional range	K
T_n	Adjustment time	s
T_v	Hold-back time	s
T_d	Attenuation time	s

i If T_v manual/auto is set to auto, T_v and T_d cannot be modified. In this case, they are derived with fixed factors of T_n .

i The temperature limits T_{ih} and T_{il} also have an effect on the control.

6.20.3 Overview of external control parameters

- External control consists of a master controller (external controller) and a slave controller (internal controller). The temperature of the consumer to be temperature controlled is also required. In general this is determined with an external “Pt100 sensor”.
- The master controller compares the set temperature with the external temperature (consumer temperature) and, from these temperatures, calculates the set temperature (set_internal) for the slave controller (internal controller).
- The slave controller compares the set temperature (set_internal) with the outflow temperature and calculates the actuating signal, i.e. the measurement used for heating or cooling.

Table 37: The following control parameters can be adapted on the master controller (external controller):

Characteristics	Designation	Unit
K _{pe}	Amplification factor	-
T _{ne}	Adjustment time	s
T _{ve}	Hold-back time	s
T _{de}	Attenuation time	s
Prop_E	Proportional range	K

Table 38: The following control parameters can be adapted on the slave controller (internal controller):

Characteristics	Designation	Unit
X _{pf}	Proportional range	K



If T_v manual/auto is set to auto, T_v and T_{de} cannot be modified. In this case, they are derived with fixed factors of T_{ne}.



The temperature limits T_{ih} and T_{il} also have an effect on the control.

Correction limitation

If a temperature jump is specified via set temperature T_{set}, the control may set an outflow temperature which is considerably higher (e.g. 50 K, possible problem with enamel reactors) than the temperature T_{ext} required in the external application. Therefore, there is a correction limitation that specifies the maximum permitted deviation between the temperature at the outflow T_{int} and the temperature in the external consumer T_{ext}.

1. Press the [Enter key] to open the menu.
2. Select the menu items → Setup → Control → Correction limit..
 - ▶ An entry window opens for the numerical value.

3. Enter the value.
4. Confirm the new value with the [Enter key].
 - ▶ The new value has been accepted.

6.20.4 Activate control variable

If the device is to be controlled to the internal control variable or an external control variable, you must set it accordingly. When setting, the old control variable with its set values is automatically deactivated. Only one control variable can be actively selected.

List of the possible control variables

- [Intern Pt1000]
- [Extern Pt100]
- [Extern analog]
- [Extern serial]
- [Extern USB]
- [Extern Ethernet]
- [Extern EtherCAT]
- [Extern Pt100-2]

Personnel: Operating personnel

1. Press the Enter key to open the menu.
2. Select the menu items → *Setup* → *Control* → *Contr. Variable*.
 - ▶ The active control variable is marked with a checkmark.
3. Scroll to another control variable and select it with the Enter key.
 - ▶ The new control variable is valid with immediate effect.

6.20.5 Change control parameters

Personnel: Specialized personnel



Press the [ESC] soft key to return to the previous display without making any changes.



Fig. 67: Change control parameters

1. Press the Enter key to open the menu.
2. Select the menu items \rightarrow Settings \rightarrow Control \rightarrow Control parameters.
 - ▶ If the control variable **extern** is active, the external control parameter is displayed on the display.
 - If the control variable **internal** is active, the internal control parameter is displayed on the display.
3. Scroll to another control parameter and select it with the Enter key.
 - ▶ An entry window opens. You can now change the numerical value. The displayed values *Max:* and *Min:* specify the limits for the value entry.
4. Press [OK] to confirm the new value.
 - ▶ The new value is active.

Enable control parameters for processing

- With *Tv manual/auto* you can define whether the control parameter *Tv* and *Td* or *Tve*, *Tde* and *Prop_E* are set manually or automatically. If the automatic setting is enabled, these control parameters are displayed with a lock and cannot be selected.
To be able to set these control parameters manually, change the control parameter *Tv manual/auto* to manual setting.

6.20.6 Manual optimization of control parameters

1. Select a control parameter set suitable for your application from \hookrightarrow Table 39 "Proven control parameter settings" on page 119.
2. Start the constant temperature equipment and the application.
3. Wait until the temperature in the external application is within ± 3 K of the set temperature. The outflow temperature must not increase or decrease any further. Fluctuations in the outflow temperature are not a problem initially.

Adjust the slave controller (internal controller):

Tests have shown that a normal P controller is perfectly adequate as a slave controller.

1. "Immobilize" the master controller by setting K_{pe} to 0.1.
 - ▶ The master controller now only works very weakly.
2. If the outflow temperature fluctuates by $> \pm 0.1$ K, continue with point 4.
If not, decrease X_{pf} until the outflow temperature fluctuates ($> \pm 0.1$ K).

3. Slowly increase X_{pf} until the fluctuations stop. Continue to increase X_{pf} by approx. 20% (safety margin).
4. If $X_{pf} < 10$ - Good outflow control circuit/hydraulics
 If X_{pf} is 10 – 15 - Fair outflow control circuit/hydraulics
 If $X_{pf} > 15$ - Poor outflow control circuit/hydraulics



If the quality of the outflow control circuit (hydraulics) is poor, the quality of the external control will also suffer considerably!

Set the master controller (external controller):

Experience has shown that it takes much longer to set the master controller than the internal controller for a pure outflow temperature control. Several days may be required for a problematic control circuit.

1. First configure the default setting for T_{ne} :
 For smaller reactors with a content of < 5 liters - $T_{ne} = 300$ s
 For medium-sized reactors with a content of 10 – 30 liters - $T_{ne} = 500$ s
 For larger reactors with a content of > 80 liters - $T_{ne} = 800 - 1000$ s
2. Adjust the set point by 5°C (5 K set point increase), record the outflow temperature and external temperature for a sufficiently long period (approx. 20 – 40 min.).
3. If the external temperature fluctuates (> 0.1 K), reduce K_{pe} until the fluctuations stop. Always wait a sufficiently long time between changes (at least 2 fluctuation cycles).
4. +20 K set point increase, wait for the transient process,
 -20 K set point decrease, wait for the transient process.
5. Assess the transient processes:
 - If an overshoot should be reduced, slowly increase T_{ve} (up to approx. 90% of T_{ne})
 - If an overshoot should be increased, reduce T_{ve} (up to approx. 60% of T_{ne})
 - Then adjust T_{de} : $T_{de} = 20\%$ of T_{ve}
 - After each change, continue with ↪ Step 4 on page 118: Implement and evaluate ± 20 K set point increases.
6. If the transient process takes too long overall,
 - T_{ne} can be reduced.
 - Also reduce a percentage of T_{ve} and T_{de} .
 - Increase K_{pe} to 150 – 200% so that the system fluctuates.
 - Then continue with ↪ Step 3 on page 118.

7. If the tendency to fluctuate increases without the overshoot being reduced to an acceptable level,
 - a) K_{pe} can be reduced easily, continue with ↪ Step 4 on page 118,
 - b) If you intend to select a larger time constant, increase K_{pe} to 150 – 200% so that the system fluctuates. Then continue with ↪ Step 3 on page 118.

Table 39: Proven control parameter settings

Device	Example	K_{pe}	T_{ne}	T_{ve}	T_{de}	Prop_E	X_{pf}	Pump level
IN 150 XT IN 250 XTW	1	4.0	300	246	24.0	20	5.0	3
	2	1.5	300	246	24.0	20	7.0	1
	3	0.7	100	84	8.0	20	7.0	4
IN 750 XT IN 950 XTW	4	1.5	200	164	16.0	20	5.0	8
	5	1.5	300	246	24.0	20	15.0	5
	6	0.4	70	61	7.0	20	12.0	6

Kryo 70 silicone oil is used in all examples.
In example 2, the pressure control with 1 bar is used on the constant temperature equipment.

Example 1

- Glass double-shell reactor with 4 liters of heat transfer liquid, reactor not insulated
- 2 metal corrugated hoses, each 1.5 m in length, $D = 10$ mm clear width

Example 2

- Glass double-shell reactor with 4 liters of heat transfer liquid, reactor not insulated
- 2 metal corrugated hoses, each 6 m in length, $D = 10$ mm clear width
- Pump with pressure control setting of $P = 1$ bar
- Bypass used

Example 3

- Application with low volume
- Application with low thermal capacity
- Hoses with low flow rate, $D < 10$ mm clear width

Example 4

- Metal double-shell reactor with 17 liters of heat transfer liquid
- 2 metal corrugated hoses, each 1.5 m in length, $D = 20$ mm clear width

Example 5

- Glass double-shell reactor with content of 4 liters, reactor not insulated
- 2 metal corrugated hoses, each 5 m in length, $D = 10$ mm clear width
- Bypass used

Example 6

- Application with low volume
- Application with low thermal capacity
- Hoses with low flow rate, $D < 10$ mm clear width
- Bypass used

6.21 Operator and viewer

Definition

- Master - Operating unit on the LAUDA device
- Command - Command Touch remote control (optional accessory with its own operating manual)
- Operator - has read privileges and write privileges
- Viewer - has read privileges only

The following operating units and interfaces are viewed:

- Master
- Command (optional accessory)
- Web server
- Control station/PC
 - connected to the constant temperature equipment via Ethernet interface, RS 232/485 interface (optional accessory), Profibus interface (optional accessory) or EtherCAT interface (optional accessory)
- Analog interface (optional accessory)
- Contact interface (optional accessory)



Allowing access to the device via the network

If you wish to have digital access to the device from the outside, this must be set in the device software beforehand.

Allowing access to the device

1. Press the [Enter key] to open the menu.
2. Select the menu items → Setup → Basic setup → Ethernet → PC control or → Web server.
 - ▶ The options [off] and [on] appear on the display.
3. Select the [on] option and press the Enter key to confirm.
 - ▶ A check mark is set. The entry has been accepted.

Range of functions of the operating units

- The full range of functions is available via the Master without restriction.
- Operation via the Command is reduced by the following functions:
 - Entry of TMax
 - Selection of the heat transfer liquid
- Operation via the Web server is reduced by the following functions:
 - Entry of TMax
 - Selection of the heat transfer liquid
 - Safety functions which require user presence at the device (e.g. menus for filling and draining)
- The control station is limited by the functionality of the interface and its protocol (command set).
- The analog interface and contact interface are restricted by their functionality and protocol.

Operator and viewer

Applies equally to Master, Command, Web server and Control station via

- Operator, once at maximum
 - The operator has all setting options available, both reading and writing, if included in the range of functions of the operating unit.
- Viewer, multiple times possible, only read privileges
 - All menus are accessible to the viewer, but no settings which change the function of the device can be made. Exceptions are entries which are necessary to log in as Operator.

The Master has Operator privileges in the set delivery condition.

If a user logs in via Web server or connects the Command operating unit, the Web server or Command has Viewer privileges.

An Operator is logged in and another operating unit requests Operator privileges (↪ “Requesting Operator privileges” on page 122). The first Operator becomes a Viewer after this Operator requests Operator privileges.

If an Operator is downgraded to Viewer, a pop-up window appears with a corresponding message.

The Master automatically becomes an Operator if a detachable control element with Operator privileges is removed.

Exception: A Command Touch with restricted user privileges. In this case, an error is first generated by the constant temperature equipment. The Master becomes the Operator again after it has been restarted (without Command).

Control station

The connection to the control station is actively monitored in the set delivery condition. If no command is received by the device via Ethernet for more than 15 seconds, an interruption of communication is detected. If connection to the control station is interrupted, the constant temperature equipment reacts according to the configuration ↪ Chapter 6.24 “Safe Mode safety fittings” on page 128.

The timeout can be set from one to 600 seconds. Use the command [OUT_SP_08_XX] via the interface for this purpose.

The function can also be executed for the Ethernet interface via the → Setup → Basic setup → Ethernet → Services → PC control → PC Timeout menu. This must be set before the start of communication.

If the monitoring of the control station is active, the Operator privileges are owned exclusively by the control station.

Neither Master, Command nor Web server can obtain Operator privileges.

Operation on the constant temperature equipment is therefore locked. If a timeout occurs during monitoring, the Operator privileges can be automatically transferred to the constant temperature equipment.

A timeout value of 0 must be set to deactivate the monitoring of the connection. The constant temperature equipment can be operated from the control station/PC or on the constant temperature equipment itself. The Operator privileges can be obtained on an alternating basis. In this case, there is no monitoring of the communication and a connection interruption is not detected.



The control station obtains Operator privileges for each write command of the control station, provided that the Operator privileges are not locked by another control element. If the control station sends write commands very frequently, operation can be made more difficult for another control element.

Cold start

The Master returns to the previous login level after the device has been switched off and on again. The same applies to the Command control element and the Web server.

An exception to this is the situation where the operating unit which last requested the Operator privileges is not connected. In this case, the Operator privileges automatically return to the Master when the device is switched on.

Status display

- If an operating unit has Viewer privileges, a lock symbol is displayed instead of the right-hand softkey or the Start/Stop button:
 - The right-hand softkey with the Start/Stop assignment is replaced by the assignment with the lock symbol in the Master.
 - The Start/Stop button is replaced by the lock symbol in the Command.
 - The Start/Stop button is replaced by the lock symbol in the Web server.
 - When operation is carried out using a control station, it is the responsibility of the user (customer) to display the status.

Requesting Operator privileges



Fig. 68: Operation on the device is locked

Locked Operator privileges

Operator privileges are requested by selecting the lock symbol:

- Press the right-hand soft key on the Master operating unit. A pop-up window appears with the query Yes/No.
- Press and hold down the Lock button on the Command remote control longer (> 0.5 s). A pop-up window appears with the query Yes/No.
- Click the Lock button in the Web server. A pop-up window appears with the query Yes/No.

Description:

Each operating unit with Operator privileges can disable the Operator privileges for other operating units/control stations (**lock**). In this case, no other operating unit/control station can obtain Operator privileges and it therefore remains a Viewer.

Locking of the Operator privileges in Command Touch:

- **User privileges** in addition to the Operator privileges and Viewer privileges are specifically available only in the Command Touch (see Command Touch operating manual).
If user privileges have been assigned/restricted via the Command operating unit (in the User configuration menu), all other operating units or the control station/PC become the viewer. Neither other operating units nor the control station can obtain Operator privileges. If an attempt is made to obtain Operator privileges, a message appears.
If a Command with restricted user privileges is disconnected from the constant temperature equipment, an error message is generated and the constant temperature equipment stops. The user must switch the device off and on again. The Master operating unit automatically becomes the Operator.

Locking of the Operator privileges in the control station

- If the monitoring of the control station is active, the Operator privileges are locked/owned exclusively by the control station. No operating units can obtain Operator privileges. If an attempt is made to obtain Operator privileges, a message appears. If the control station drops out, the constant temperature equipment is switched off and switched on again, an alarm is triggered or the control station monitoring is deactivated. Exclusive ownership is withdrawn from the control station.

Locking of the Operator privileges in the Master

- If a Safe Mode is triggered, the Operator privileges are transferred to the Master and locked/owned exclusively there. If the Safe Mode is deactivated, the exclusive ownership is withdrawn from the Master.

6.22 Web server LAUDA Command

The embedded Web server

The LAUDA device is equipped with an integrated Web server. The Web server is used to visualize device-internal and process-relevant data such as temperature, pressure and flow rate. The scope of the information displayed depends on the device, device type and installed accessories.

You can use the following software to access the Web server:

- **LAUDA Command app:**
Available in the app stores for mobile devices based on iOS and Android and in the Windows Store for Windows-based PC systems. The LAUDA Command app can also be downloaded from the LAUDA homepage for Windows-based PC systems. Open the LAUDA homepage, tap → *Services* → *Download center*. In the Download center, chose the [Software] option in the [Document type] drop-down list.
- **Web browser:**
Connection to the LAUDA device via a browser.

Requirements

- The LAUDA device and the PC/control station must be connected to the same network. The network settings can either be set automatically (*DHCP on*) or manually (*DHCP off*) on the device ↪ Chapter 4.7.3 “Configuring the Ethernet interface” on page 46.



Connection to the device via the LAUDA Command App

LAUDA recommends using the LAUDA Command app. If you use this app, state-of-the-art security mechanisms which offer a very high level of security against digital threats are automatically put in place. In addition to this, the App has an integrated search service for LAUDA devices in the local network, so that manual entry of a host name or IP address is no longer necessary.

Operating the device with the app

You are using the LAUDA Command app. This automatically searches for existing devices in the network. The devices found are displayed in a list. Select the required device. Connection to the device is established. If a connection to a device was established before closing the App, connection to this device is established when the App is started again.

Security with the web browser

The LAUDA device can be accessed with a web browser if users cannot use the LAUDA Command app for technical reasons or IT guidelines prohibit this.

You must install the LAUDA CA certificates (Root CA, Device CA) to obtain a high level of security when using a web browser.

You must carry out the following before using a web browser:

1. Download the CA certificates from the LAUDA homepage before connecting for the first time.
Open the LAUDA homepage, tap → *Services* → *Download center*.
2. In the Download center, chose the [Certificate] option in the [Document type] drop-down list.
 - ▶ A list of the certificates appears.
3. Tap the relevant certificate.
 - ▶ The download starts and a zip file is downloaded.
4. Install the certificates on all end devices which will be used later to access the LAUDA device.
5. Answer the question about whether you trust the LAUDA certificates with [Yes].
6. Compare the Common Name of the device certificate with the Controller ID of your LAUDA device during the initial connection setup.
The number can be displayed in the device menu → *Device Status* → *Controller ID*.
 - ▶ The 24-character identification number is displayed. This can consist of the numbers 0-9 and the letters A-F. This is shown on the display in three number blocks (digits 1-8, 9-16 and 17-24).
7. Confirm the connection.



Fig. 69: Controller ID

Operating the device via the Web server

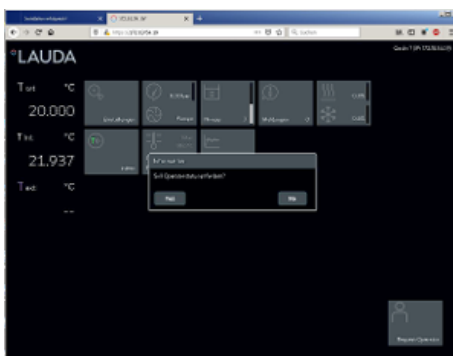

Fig. 70: Web server in the browser window

Operation of the LAUDA devices via the web server is carried out in the same way as operation via the operating unit on the device. If required, please refer to the respective descriptions of operation provided in this operating manual.

The operation of the device via the LAUDA Command App is very similar to the remote control Command Touch, whose operating instructions can be downloaded from our homepage. Open the LAUDA homepage, tap → *Services* → *Download center*. In the Download center, chose the [PRO] option in the [Product line] drop-down list.

You need the IP address or the serial number of the constant temperature equipment when you use the web browser. Enter the IP address or the serial number in the address line of the browser. Connection to the device is established.

Viewing the IP address

Select the menu items → *Setup* → *Basic setup* → *Ethernet* → *LAN configuration* → *Local IP address*.

Viewing the serial number

Select the menu items → *Device Status* → *Serial numbers*.

Cookies

Cookies must be activated if you use a web browser. The device creates a cookie with a connection-specific token which is generated during the initial mutual authentication. This information is lost if the cookie is rejected or deleted. Authentication must then be repeated the next time a connection is established.

Contact your network administrator if you require further assistance in implementing secure access.

Two-Factor Authentication (2FA) for increased security

Two-Factor Authentication is an authentication using a combination of two different and independent paths. The user is checked by the remote station and the remote station is checked by the user.

In the case of LAUDA, a user with automatically generated access data is created in the constant temperature equipment during the 2FA. The access data is stored in the App in the form of a token and as a cookie in the web browser. The token is valid for 6 months. In addition to this, all registered users (tokens) can be deleted via the Master on the constant temperature equipment. The user must repeat the 2FA in these cases.

The 2FA must be performed:

- At the first connection.
- When the token is no longer valid.
- When the cookie is no longer valid.
- If the cookie has been deleted in the browser or has not been saved.

The user is automatically prompted by the App or the web browser if a 2FA is necessary. A 6-digit one-time password is shown on the display of the constant temperature equipment when performing the 2FA. This is valid for 5 minutes. Type the code displayed in the Web client and confirm your entry. The connection is continued if authentication is successful. If an error occurs, check whether your entry was correct.

6.23 Cloud service LAUDA.LIVE



Fig. 71: Home window with cloud in the status bar

The LAUDA Integral enables the communication of device data to the cloud-based service LAUDA.LIVE. The service provides various optional features and offers, such as remote maintenance.

The LAUDA Integral IN enables the communication of device data to the cloud-based service LAUDA.LIVE. The service provides various optional features and offers, such as remote maintenance.

Please contact LAUDA or visit our website for detailed information about LAUDA.LIVE and its services.

To implement the LAUDA.LIVE service, device data is exchanged with the LAUDA.LIVE cloud via an encrypted connection, enabling the LAUDA service to remotely maintain the constant temperature equipment.

Requirements

- The LAUDA Integral has direct Internet access to LAUDA.LIVE via the Ethernet interface. It may be necessary to adapt the network settings and local network conditions ↪ Chapter 4.7.3 “Configuring the Ethernet interface” on page 46.
Note: The constant temperature equipment uses a dynamic IP address via DHCP by default. No further network settings are necessary provided that this is supported in the local network and Internet access is enabled.
- The LAUDA Integral IN has direct Internet access to LAUDA.LIVE via the Ethernet interface. It may be necessary to adapt the network settings and local network conditions ↪ Chapter 4.7.3 “Configuring the Ethernet interface” on page 46.
Note: The constant temperature equipment uses a dynamic IP address via DHCP by default. No further network settings are necessary provided that this is supported in the local network and Internet access is enabled.
- Users who cannot provide the constant temperature equipment with Internet/LAUDA.LIVE access via their local network for technical reasons or whose IT policies prohibit this can use a LAUDA wireless gateway as an alternative (please contact LAUDA for further information).



LAUDA.LIVE access and data transmission is disabled by default.

Allowing access to the LAUDA.LIVE cloud

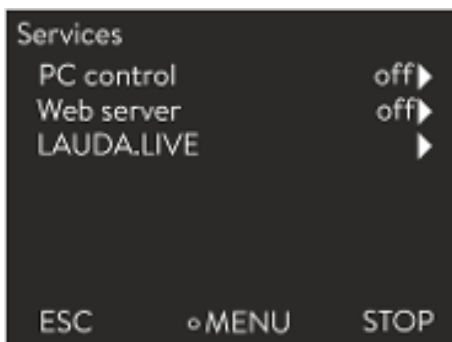

1. Press the Enter key to open the menu.

Fig. 72: Services

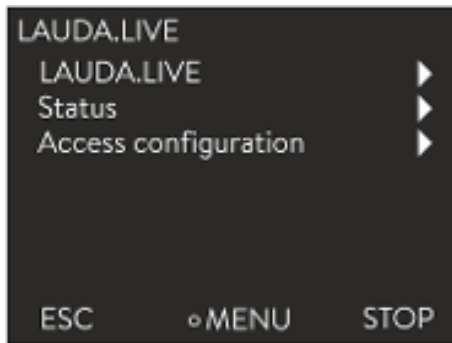

Fig. 73: LAUDA.LIVE menu

2. Select the menu items → Setup → Basic setup → Ethernet → Services → LAUDA live → LAUDA live [off/on].
 - ▶ The options [off] and [on] appear on the display.
3. Select the [on] option and press the Enter key to confirm.
 - ▶ The entry has been accepted.

After switching on, the constant temperature equipment is registered and authenticated via an encrypted TLS connection using a device-specific X.509 certificate in LAUDA.LIVE. The connection can only be initiated on the device side for security reasons. A successful connection to LAUDA.LIVE is indicated in the same menu item under [Status]:

connected - currently connected to LAUDA.LIVE

connecting - connecting to LAUDA.LIVE

off - switch off LAUDA.LIVE



Fig. 74: Status bar with cloud

If a connection to LAUDA.LIVE already exists, a cloud appears in the status bar of the home window.

Since LAUDA provides the user with full control over the data to be transferred, device data is not transferred until LAUDA.LIVE access has been configured.

Configuring LAUDA.LIVE access

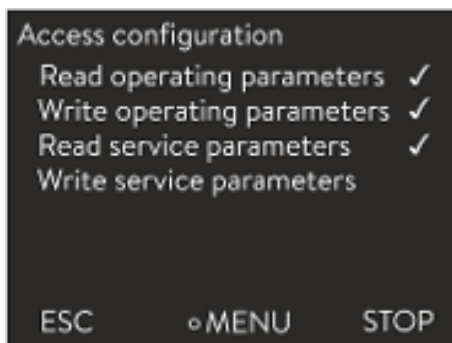

Fig. 75: Access configuration

1. Press the Enter key to open the menu.
2. Select the menu items Setup → Basic setup → Ethernet → Services → LAUDA live → Access configuration.
 - ▶ The following options appear on the display:
3. Select the desired option and press the Enter key to confirm.
 - ▶ A check mark is set. The entry has been accepted and the relevant option is enabled.



The Access configuration menu enables the user to independently define the data which may be transferred: [Op. param. readable] and [Service prm. readable].

A distinction is made between operating parameters (such as the set point/ actual temperature (Tset/Tint/Text)) and the service parameters (internal device parameters). The operating parameters are essentially the parameters which are displayed to the user on the device display and can be modified by the user. In contrast, the service parameters are only available to the LAUDA Service.

Changing the data in the constant temperature equipment from the cloud, e.g. as part of remote maintenance by the LAUDA Service, is activated on the device side via [Op. param. writable] and [Service prm. writable].

In addition to measures provided in LAUDA.LIVE for authorizing access and changing device data, e.g. 2-factor authentication, the device-side access configuration is used by the user for basic restriction/control of the LAUDA.LIVE services.

6.24 Safe Mode safety fittings

Aim of the Safe Mode

The Safe Mode enables the user to determine an emergency operating mode for the device and application in advance. In the event of faults in the process (e.g. failure of the communication with the control station), it is possible to switch to this safe operating mode quickly and easily.

The device remains in this safe operating mode until Safe Mode is manually deactivated.

What happens with **activated** Safe Mode?

- The parameters configured in Safe Mode are set.
- A warning *103 Safe Mode* appears in the display (Home window).
- The parameters affected by Safe Mode cannot be changed.
- Active programmers are terminated.
- The "Set point offset" function is switched off.
- The Operator privileges of the constant temperature equipment are assigned to the Master operating unit ↪ "[Locking of the Operator privileges in the Master](#)" on page 123. The Operator privileges cannot be relinquished during the active Safe Mode.

Which events lead to the **activation** of Safe Mode?

- communication with the control station being interrupted
- manually by the user
- via a command over an interface module ↪ Table 42 "Interface module and interface commands" on page 131
- by alarms ↪ Table 43 "Alarms which activate the Safe Mode function" on page 131

How does an alarm affect Safe Mode?

- Not all alarms trigger Safe Mode.
- Some alarms ignore the settings of the control variable in the Safe Mode menu.

What indicates that Safe Mode is **activated**?

- In the device display (Home window).
- Via the warning "103 Safe Mode active"
- Via the error in the interface command ↪ Chapter 4.7.8 "Error messages" on page 61.

What happens when Safe Mode is **activated** by an alarm?

- *Alarm* is displayed.
- Safe Mode is activated.
- Safe Mode cannot be deactivated until the alarm has been acknowledged.



*Safe Mode can only be activated if the function of the Safe Mode was previously **switched on** in the menu.*

Activating Safe Mode by disconnecting from the control station

To activate Safe Mode on drop-out, activate the Safe Mode function via the menu and configure the Safe Mode parameters. In addition, activate the control station monitoring function  “Control station” on page 121. After monitoring has been activated, the constant temperature equipment actively checks the sending of commands from the control station after connecting to it.

The control station must send a command to the constant temperature equipment periodically. The user must define the time the system waits before reporting a communication fault. If the control station fails to send a command within the specified time, the interface (Ethernet) sends a corresponding command to the constant temperature equipment. In this way, Safe Mode is activated and a warning generated.



The device triggers Alarm 22 if the Safe Mode function is switched off  Table 44 “Constant temperature equipment alarms” on page 151.

Switching off the activated Safe Mode

If Safe Mode has been activated, the operator can switch off Safe Mode in the associated menu. The parameters set by the Safe Mode will be retained after the deactivation of Safe Mode. The programmer is not continued automatically. If the “Set point offset” function is required, it must be activated manually.

Compatibility

The Safe Mode function cannot be used together with the EtherCAT module. The Safe Mode function is switched off and locked when using EtherCAT.



If an alarm has triggered Safe Mode, the alarm on the constant temperature equipment must be reset first. Only then can Safe Mode be switched off and then back on.

Switching off Safe Mode via an interface command is not possible.

Safe Mode menu

1. Press the [Enter key] to open the menu.
2. Select the  Safe Mode menu item and confirm the entry.
 - ▶ The submenu opens.

Table 40: Settings in the *Safe Mode* menu

Menu items in the <i>Safe Mode</i> menu	Description
Switch on/off of the <i>Safe Mode</i> function Function <input type="checkbox"/> off <input type="checkbox"/> on	Here you can switch the <i>Safe Mode</i> function on or off (default value). Select one of the following options: <input type="checkbox"/> <i>off</i> : <i>Safe Mode</i> is switched off. <input type="checkbox"/> <i>on</i> : <i>Safe Mode</i> is switched on. <input type="checkbox"/> Only when the <i>Safe Mode</i> function is switched on do the following menu items appear: <ul style="list-style-type: none"> ● Start ● Configuration
Manual activation of the <i>Safe Mode</i> function Start <input type="checkbox"/> off <input type="checkbox"/> on	Manual activation of the <i>Safe Mode</i> function: <input type="checkbox"/> Option <i>off</i> : <i>Safe Mode</i> is not activated. <input type="checkbox"/> Option <i>on</i> : <i>Safe Mode</i> is activated.
Deactivation of <i>Safe Mode</i> Stop <input type="checkbox"/> No <input type="checkbox"/> Yes	<input type="checkbox"/> Stop only appears when <i>Safe Mode</i> has been activated. <input type="checkbox"/> Deactivation of <i>Safe Mode</i> is only possible when there are no pending alarms.
Configuration	In this submenu you set the parameters with which the device will continue to work when the <i>Safe Mode</i> is activated → Table 41 “Settings in the <i>Configuration</i> menu” on page 130.

Table 41: Settings in the *Configuration* menu

Menu items in the <i>Configuration</i> menu	Description of the options, actions with <i>Safe Mode</i> activated
<i>Set point change</i> This menu item is hidden when <i>Safe Mode</i> is activated.	Select one of the following options: <input type="checkbox"/> <i>Change set point</i> : When <i>Safe Mode</i> is activated, the device adjusts to the new setpoint previously set in the <i>Setpoint</i> menu. <input type="checkbox"/> <i>unchanged</i> : If <i>Safe Mode</i> is activated, the device retains the setpoint with which it previously worked.
<i>Set point</i>	Here you enter the setpoint T_{set} with which the device continues to work after activated <i>Safe Mode</i> . This value is stored in the <i>Safe Mode</i> parameters.
<i>Control</i>	Select one of the following options: <input type="checkbox"/> Option <i>Unchanged</i> : If <i>Safe Mode</i> is activated, the device retains the control variable with which it previously worked. <input type="checkbox"/> Option <i>Internal Pt1000</i> : With <i>Safe Mode</i> activated, the device switches to the internal Pt1000 control variable.

Table 42: Interface module and interface commands

Interface	Interface command	ID	Description
Ethernet interface	OUT_MODE_06_1	72	Interface command activates <i>Safe Mode</i> Activation is not possible if there is an error
RS 232/485 interface	OUT_MODE_06_1	72	Interface command activates <i>Safe Mode</i>

Table 43: Alarms which activate the *Safe Mode* function

Alarm	Description	Description of action
Alarm 9 External actual value is not available	Temperature value is not transmitted from the external sensor.	The settings of the temperature setpoint are accepted from <i>Safe Mode Configuration</i> menu. Control variable is switched automatically to internal.
Alarm 12 Current interface 1, interruption	Interruption to the analog module	The settings of the temperature setpoint and control variable are accepted from the <i>Safe Mode Configuration</i> menu.
Alarm 13 Current interface 2, interruption	Interruption to the analog module	
Alarm 15 Fault at the digital input	Fault on the digital input/switching contact	
Alarm 16 Refilling has failed	Heat transfer liquid level is too low.	

6.25 Importing and exporting data

6.25.1 Importing data

Importing data from a USB stick

You can import the following data from a USB stick:

- Control parameters
- Analog module config.
- Contact module config.

If you have previously exported the control parameters, analog module configuration or contact module configuration of a device to a USB stick, you can use the USB stick to transfer them to another device.

Personnel: Operating personnel

1. Insert the USB stick in the USB host on the operating unit of the machine.
2. Press the Enter key to open the menu.
3. Select the → *Data export/import* → *Data import* menu items in the main menu.
 - ▶ The submenu opens.
4. Select one of the following options:
 - Control parameters
 - Analog module config.
 - Contact module config.

- [Control parameters]
This data record is located in the directory *LAUDA / USER* and contains the file *CTRLPARA . INI*. Only such a file can be exported. The file will be overwritten on re-export.
The file contains all the temperature control parameters as well as the temperature limits *Tih* and *Til*. The file is designed to transfer the settings of the control parameters from one device to another.
- [Analog module config.]
[Contact module config.]
These data records can only be exported if an analog module or contact module has been connected to the constant temperature equipment. The configuration is stored in the *LAUDA / USER* directory in the *ANACFG . INI* or *CONTCFG . INI* file. Only such a file can be exported in each case. This file will be overwritten on re-export. The file contains the complete configuration of the connected analog module or contact module. The file is designed to transfer the configuration from one constant temperature device to another.

Personnel: ■ Operating personnel

1. Insert the USB stick in the USB host on the operating unit of the machine.
2. Press the Enter key to open the menu.
3. Select the → *Data export/import* → *Data export* menu items in the main menu.
 - ▶ The submenu opens.
4. Select one of the following options:
 - n [Temperature graphic]
 - n [Device status]
 - n [Device data]
 - n [Control parameters]
 - [Analog module config.]
 - [Contact module config.]
5. Start the export by pressing the Enter key [OK].
Messages appear on the display during the export:
 - Data export to USB stick started.
 - Data export to USB stick has been successfully completed.
Confirm the message by pressing the Enter key [OK] once the data export has been completed.

If the data export was not successful, the message "Data export to USB stick failed" appears on the display. Press [OK] to confirm.

Check that the USB stick was inserted correctly and that there is enough free memory space (at least 1 MB).

Start the data export again.

6.26 Operation with inert gas blanket



WARNING!
Gas displaces atmospheric oxygen

Danger of asphyxia

- Only use the inert gas overlay in areas with good aeration.

The IN 2560 XTW is equipped as standard with a connection for an inert gas blanket (e.g. dry nitrogen). The properties of the heat transfer liquid can be maintained for longer with an inert gas overlay. The gas is guided directly over the surface of the heat transfer liquid in the device. The gas flows out through the device overflow.

Advantages of an inert gas blanket:

- The inert gas reduces the condensation of moisture in the heat transfer liquid.
- The inert gas reduces oxidation of the heat transfer liquid.
- The inert gas increases the service life of the heat transfer liquid.

Please note:

- The inert gas blanket may not be used in closed rooms. The operating areas must be well ventilated. Alternatively, use an extraction system.
- An overflow hose with a collecting vessel must be connected to the device overflow.
- Adjust the flow rate of the inert gas source to the desired flow rate (maximum pressure 0.1 bar) with an external fitting.

For use, connect an inert gas source to the connection (workshop coupling NW 7) marked with this graphic (see left).



7 Operation of a high-temperature thermostat

Safety instructions for high-temperature thermostats with water counter-cooling

High-temperature thermostats with a cooling water connection always require a cooling water supply, even if the devices are only used in heating mode.

Degas mode and automatic degassing

Degassing in high-temperature thermostats operates in the same way as in process thermostats.

Draining the device

Draining high-temperature thermostats, see ↪ “Draining the high-temperature thermostat” on page 158.

8 Operating a device with pressure overlay

8.1 Warnings, safety instructions and further information

The warnings and safety instructions listed below apply to devices with pressure overlay.



WARNING!
Overflow of heat transfer liquid

Slipping or falling over

- Do not overfill the device. Pay attention to the level indicator of the device in this respect.



WARNING!
Gage pressure

Explosion, ejection of parts

- The gage pressure which escapes from the device through the overflow pipe may only be discharged in a safe area. The overflow pipe may be not closed, also not partially, or tapered.

Intended use

- The thermostat with pressure overlay may only be used for the temperature control and circulation of a non-flammable heat transfer liquid through a closed circuit.

Unintended use

The following are considered examples of unintended use:

- Medical applications
- Use in hazardous areas
- Use for controlling the temperature of foodstuffs
- Operation with a glass reactor without gage pressure protection
- Connection to a non-closed hydraulic circuit
- Outdoor installation

Reasonably foreseeable improper use

The following are considered cases of foreseeable misuse:

- Operating the device without heat transfer liquid
- Operating the device with an unsuitable heat transfer liquid
- Connecting hoses incorrectly

Safety instructions for the assembly

- There is an overflow pipe on the rear of the device. Extend the overflow pipe with a pipe or a hose.
- The extension should end in a stable and heat-resistant vessel.
- The connected extension should be as short as possible and must not reduce the diameter of the overflow pipe.

Safety instructions for operating the pressure overlay

- The flow rate of the heat transfer liquid at high cooling capacities (> 15 kW) should be at least 40 l/min or equivalent to pump level 4.
- When operating on a pressure-sensitive application (e.g. a glass reactor), you must install a pressure relief device (e.g. a safety valve) in the hydraulic circuit.
- When determining the maximum process temperature, please bear in mind that the temperature in the reverse flow is higher than the temperature in the outflow in "cooling" operation. The temperature difference from the outflow to the reverse flow depends on the heat capacity of the heat transfer liquid, the pump level and the amount of heat introduced by the application.



Set the process temperature and the overlay pressure in such a way that the heat transfer liquid cannot boil in the constant temperature equipment or in the application.

Pressure overlay parameters

The following parameters must be set for the pressure overlay:

- Tmax - The Tmax value is the maximum operating temperature. It must be at least 5 K below the boiling temperature of the heat transfer liquid. The Tmax value is measured in the outflow of the temperature control unit.
- Tmax_return - The Tmax_return value is the maximum operating temperature. It must be at least 5 K below the boiling temperature of the heat transfer liquid. The Tmax_return value is measured in the reverse flow of the temperature control unit. The Tmax_return value is particularly relevant to safety at high outflow temperatures with high cooling loads.
- Tih - The temperature limit value Tih limits the input of the set temperature. The maximum value of Tih must be 2 K below the value of Tmax. The constant temperature equipment reduces the heating output when Tih is reached during operation.
- Set pressure - The set pressure (Pset) is the pressure overlay which is determined from the heat transfer liquid and the desired operating temperature. Please bear in mind that the pressure overlay refers to the relative pressure. The ambient pressure must be taken into account when setting the pressure overlay. The possible setting range for the set pressure is 0 to 4 bar.

8.2 Menu structure of the pressure overlay

The menu structure for a device with pressure overlay is shown.

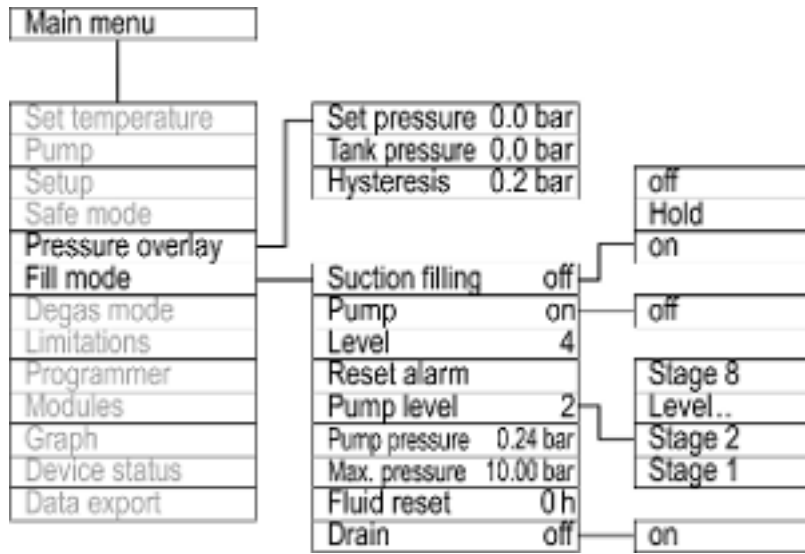

Fig. 77: Menu structure of the pressure overlay

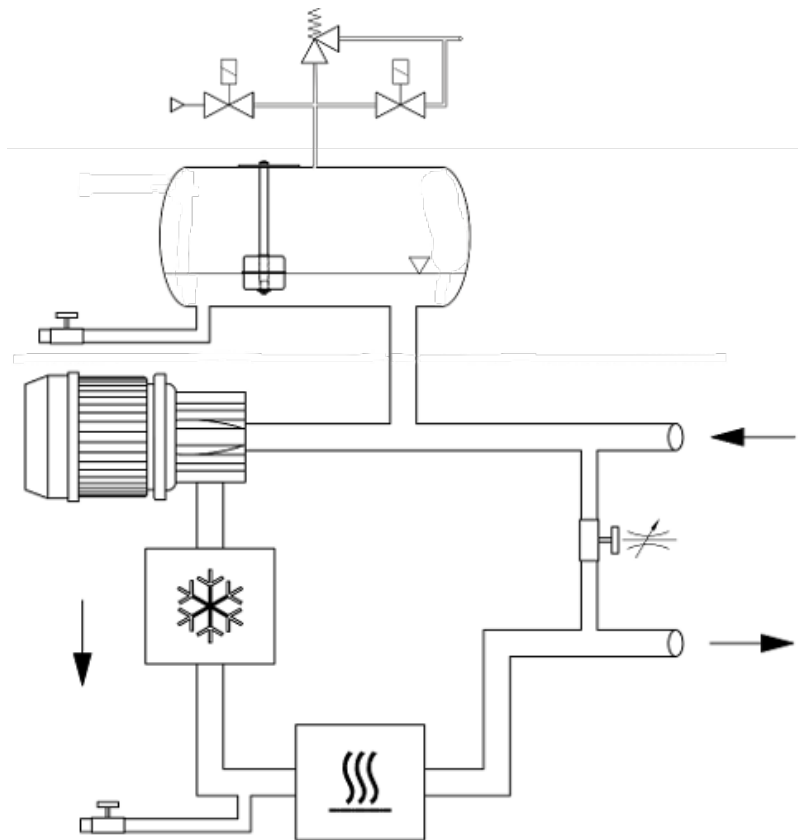

Fig. 78: Schematic of the hydraulic circuit for devices with pressure overlay

8.3 The system pressure in devices with pressure overlay

$$P_{\text{system}} = P_{\text{static}} + P_{\text{pump}}$$

Fig. 79: Formula for system pressure

The system pressure in the hydraulic circuit from the constant temperature equipment to the application is composed of the static pressure, which is influenced by the pressure overlay, and the dynamic pressure, which is generated by the pump.

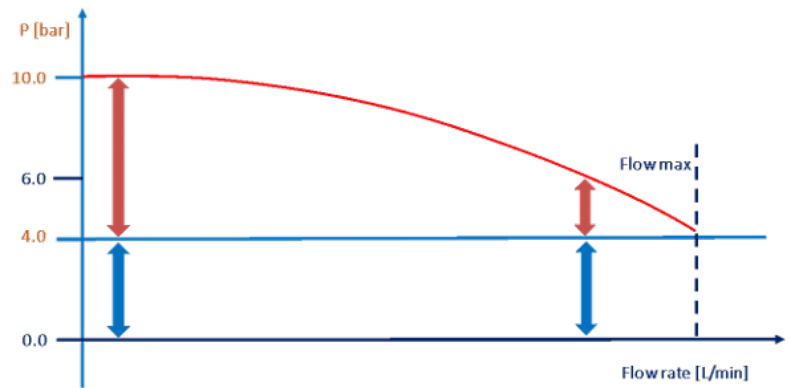

Fig. 80: Graph of system pressure

System pressures of up to 11 bar can occur owing to the maximum pressure overlay of 4.5 bar and the maximum pump pressure of 6.2 bar.

8.4 Setting the parameters for a pressure-stable application up to the maximum system pressure

If the application is stable against the heat transfer liquid pressure of up to 11 bar, select the following settings for the parameters:

- Tmax - 145 °C (water-glycol mixture)
- Tmax_return - 165 °C
- Tih - This is the highest temperature permissible for the heat transfer liquid → “Pressure overlay parameters” on page 137
- Set pressure (Pset) - 4.0 bar



The set pressure (Pset) is stated as a **relative** pressure in relation to the ambient pressure. A Pset = 4 bar is therefore equivalent to an absolute pressure of around 5 bar at sea level.

8.5 Setting the parameters for a pressure-stable application



WARNING!
Escape of steam or fluid

Scalding

- Tmax, Tmax_return, Tih and the pressure overlay Pset must be set according to the specifications in the operating manual.

If applications may only be subjected to a maximum pressure (system pressure) of less than 10 bar, this can be set via the pressure limitation in the pump settings. This pressure limitation means that the pump performance is automatically limited by the static pressure of the pressure overlay on a priority basis.

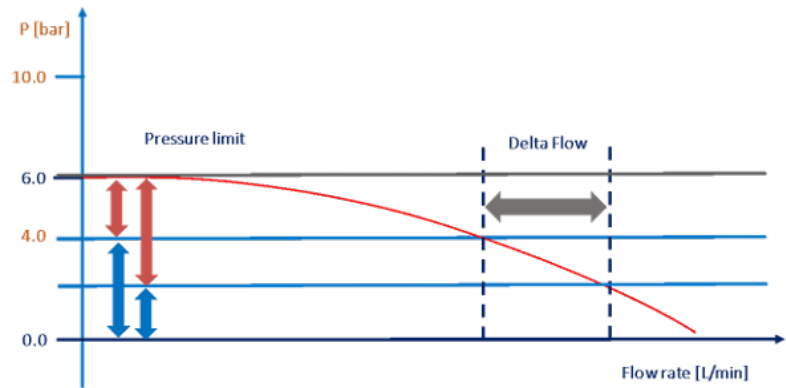

Fig. 81: Graph of system pressure

If the pressure overlay is set too high, the remaining pressure of the pump may not be sufficient for the desired volume flow of the heat transfer liquid. It may therefore be necessary to reduce the pressure overlay, in order to obtain a higher volume flow.

A reliable temperature control process is only provided if the heat transfer liquid does not boil. Boiling processes occur when the steam pressure of the heat transfer liquid falls below the static pressure (pressure overlay). The temperature of the heat transfer liquid must be at least 5 K below the steam pressure curve to prevent this.

Example:

Temperature (°C)	Steam pressure (bara) 50:50	Steam pressure (bara) Kryo 30
90	0.6	0.5
95	0.7	0.6
100	0.8	0.7
105	1.0	0.8
110	1.1	1.0
115	1.3	1.1
120	1.5	1.3
125	1.7	1.5
130	2.0	1.7
135	2.3	2.0
140	2.6	2.3
145	3.0	2.6
150	3.4	3.0
155	3.9	3.4
160	4.5	3.9
165	5.1	4.4

Fig. 82: Table for steam pressure of water-glycol mixture

- If you wish to maintain the temperature of a water-glycol mixture (in a ratio of 40:60, equivalent to LAUDA Kryo 30) at 130 °C, read off the steam pressure of the heat transfer liquid at 135 °C. This is stated as 2.0 bar **absolute** (see steam pressure table).
- Set the pressure overlay (= set pressure Pset) to 1.5 bar.
 - Calculation: Steam pressure - ambient pressure + 0.5 bar safety margin
 - Note: The set pressure (Pset) is stated as a **relative** pressure in relation to the ambient pressure.
- Set TiH 2 K above the set point (in this example 132 °C); this means that the constant temperature equipment will not heat any higher.
- If you wish to dissipate heat, the reverse flow temperature is higher than the outflow temperature. Use the highest system temperature to determine the pressure overlay.



When operating on a pressure-sensitive application (e.g. a glass reactor), you must install a pressure relief device (e.g. a safety valve) in the hydraulic circuit.

If processes in the application lead to higher temperatures, boiling-out may occur. This causes the temperature control to break down, but the constant temperature equipment continues to control the temperature as far as possible. To solve the problem, you must either increase the pressure overlay or reduce the maximum set temperature.

Tmax and Tmax_return are parameters which are relevant to safety. If the values of Tmax or Tmax_return are exceeded, the constant temperature equipment switches off with an alarm. Tmax_return can be set higher than Tmax, since the reverse flow temperature in cooling processes can be significantly higher than the outflow temperature, which is monitored by Tmax. Set these values as high as safety permits.

Do not use these parameters to control degassing processes, otherwise the temperature control process may be completely interrupted.

8.6 Filling and operating a device with pressure overlay

Compressed air supply

A supply of compressed air (or nitrogen) must be available to enable operation with pressure overlay.

- Pressure: 5 - 8 bar
- The compressed air must be free of oil.
- 1 kg of compressed air must not contain more than 1.7 g of water.
- Workshop coupling NW 7.2 (on the constant temperature equipment)



Only these heat transfer liquids are permitted for devices with pressure overlay:

- LAUDA Kryo 30
- Water-glycol mixture

Filling with heat transfer liquid



WARNING!
Overflow of heat transfer liquid

Slipping or falling over

- Do not overfill the device. Pay attention to the level indicator of the device in this respect.

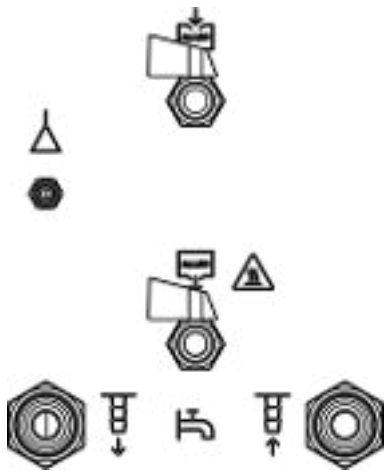

Fig. 83: Connecting sleeves to the Integral IN 2050 PW

1. Completely assemble the hydraulic circuit (with application, hoses, constant temperature equipment and any additional equipment).



2. Connect the compressed air hose to the compressed air connector of the constant temperature equipment (see symbol).
3. Prepare the heat transfer liquid.
4. Unscrew the sealing cap from the filling nozzle of the device. Screw a hose nozzle with a hose onto the filling nozzle (G 3/8" exterior thread (male)).
5. Insert the hose in the canister with the heat transfer liquid.
6. Switch on the constant temperature equipment.
7. Press the [Enter key] to open the software menu.
8. Select the heat transfer liquid you wish to use and confirm your selection.
9. Open the filling tap. To do this, turn the tap counterclockwise.
10. Select → *Fill mode* → *Suction filling on* in the menu.
11. Enter the desired fill level in the menu.
12. Filling starts with negative pressure. Filling ends automatically at the fill level previously entered.
 - ▶ During filling, operation alternates between the heat transfer liquid flowing into the constant temperature equipment and the pumping of the heat transfer liquid into the application. This change takes place automatically. Any operator actions which may be required as well as the current filling process are shown in the display in Fill mode.
13. If more than one canister of heat transfer liquid is required, the tap on the filling nozzle must be closed when the canisters are changed.
14. Vacuum filling ends when the previously entered fill level is reached. Close the tap on the filling nozzle, remove the hose and screw on the sealing cap.
15. You should degas the heat transfer liquid after filling.

Pressurized devices can also be filled by means of a pressure pump ↪ “Filling with a pressure pump” on page 75.

Activating and deactivating the pressure overlay



A temperature set point T_{set} of more than 90 °C can only be entered when the pressure overlay is activated.



Activating

1. Connect the compressed air hose to the compressed air connection of the constant temperature equipment.
2. Switch on the constant temperature equipment.

3. Press the [Enter key] to open the software menu.

Select the menu items *Pressure overlay* → *Set pressure*.

- ▶ An entry window opens. The values displayed for *Max: 4.0* and *Min: 0.0* specify the limits for the value entry.

4. Enter the value and press the Enter key to confirm.

- ▶ The constant temperature equipment starts the pressure overlay directly after the input. The supply of compressed air is automatically stopped after the entered pressure has been reached. If the application loses the heat transfer liquid or it is drained, the pressure overlay is switched off when the low level is reached and the gage pressure in the expansion vessel is released.

If the entered gage pressure cannot be reached, the device indicates a warning or the device will go into the Fault state, depending on whether the current temperature of the heat transfer liquid is below or above the boiling temperature at atmospheric pressure

Operation

5. The Integral thermostats with pressure overlay have a built-in safety valve which limits the pressure in the expansion vessel to a maximum of 4.5 bar. This safety valve is not intended for pressure compensation during regular operation. In the event of a fault, this safety valve prevents a further increase in pressure in the expansion vessel but not in the application!

6. Only switch off the constant temperature equipment when the heat transfer liquid has a moderate temperature (room temperature).

Deactivating

7. Select the menu items *Pressure overlay* → *Set pressure*.

- ▶ The Input window opens.

8. Enter the value 0 for Pset and press the Enter key to confirm.

- ▶ The pressure overlay has been switched off. Ambient pressure is reinstated in the pressure vessel of the device.

Draining



WARNING!
Discharge of liquid under high pressure

Slipping hazard

- Reset the pressure overlay to 0 bar before emptying and use the pressure gage on the side of the device to check the pressure in the device.



- Bring the heat transfer liquid to room temperature before draining. Ensure that the heat transfer liquid in the hydraulic circuit is not below 5 °C or above 40 °C before draining, otherwise there is a risk of injury from scalding or frostbite.
- Check that the pressure overlay has been deactivated and that there is no gage pressure in the system. To check, look at the pressure gage and press the button to release any excess pressure which may still be present.
If required, press the button for releasing the compressed air with an elongated object.
- Switch the constant temperature equipment to the "Standby" status to drain the hydraulic system.
- Draining continues in the same way as in Integral devices without pressure overlay.

9 Maintenance

9.1 Warning notes for maintenance

DANGER!
 Contact with live or moving parts

Electric shock, impacts, cutting, crushing

- The device must be disconnected from the mains power supply before any kind of maintenance is performed.
- Only skilled personnel are permitted to perform repairs.

CAUTION!
 Contact with hot or cold device parts, accessories and heat transfer liquid

Scalding, hot or cold burns

- Allow device parts, accessories and heat transfer liquid to reach room temperature before touching.

Protective equipment:

- Safety glasses
- Protective gloves
- Protective work clothing

9.2 Maintenance intervals

The maintenance intervals described in the following table must be observed.

Interval	Maintenance work
Weekly	Check that the drain taps are closed and tight. The sealing caps must be present on the drain taps and tightened.
Monthly	Check the exterior of the device for any damage.
	Check the external hoses for material fatigue. Check the hoses and screw connections for leaks.
	Clean the air-cooled condenser.
	Clean the filter screen in water-cooled devices.
	Check the function of the overtemperature protection.
	Check the function of the low-level protection.
Quarterly	Descale the cooling water circuit. (a shorter interval must be selected, depending on the water hardness and operating period)
Six monthly	Check the heat transfer liquid for usability.
every ten years	For IN 2050 PW and IN 2560 PW: Check that the externally installed safety valve is functioning properly.

9.3 Cleaning the device



WARNING!
Risk of cleaning agent entering the device

Electric shock

- Only use a slightly damp cloth to clean the device.

Please also note the following:

- Only use water and detergent to clean the operating unit. Do not use acetone or solvent as these substances will permanently damage the plastic surfaces.
- Ensure that the device is decontaminated after coming into contact with hazardous materials.
- It is forbidden to use decontaminants or cleaning agents that may react with parts of the device or materials contained in those parts and potentially pose a **hazard**.
- We recommend using ethanol as a decontaminant. If you are unsure whether decontaminants or cleaning agents are compatible with parts of the device or the materials contained in those parts, please contact the LAUDA Service department.

9.4 Cleaning the air-cooled condenser

This section is relevant for:

- Air-cooled devices



WARNING!
Risk of mechanical damage to refrigerant circuit

Explosion, fire

- Do not use pointed objects to clean the condenser.

- Protective equipment:
- Safety glasses
 - Protective gloves
 - Protective work clothing

With increasing operating time, the condenser becomes clogged with dust from the environment. This leads to a performance loss of cooling output.

1. Switch off the device.
2. Pull out the mains plug.

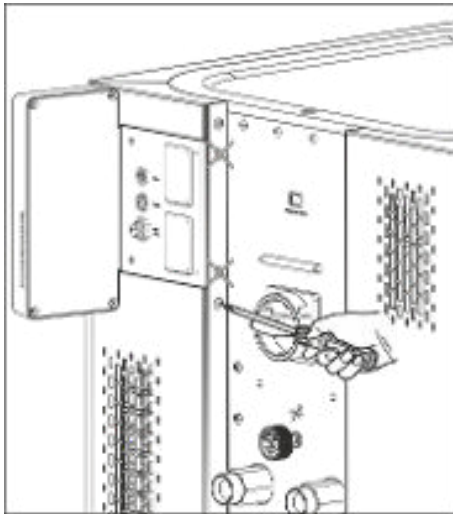

Fig. 84: Removing the front panel

3. Remove the screws with which the front panel is screwed to the columns on both sides of the device. Remove only the screws for the lower front panel in the case of two-piece front panels.



The two marked screws must not be removed. They fix the plate of the module plug areas or the operating unit to the device.

4. Remove the front panel by holding it with both hands, right and left, and pulling the front panel towards you. Remove the front panel slowly and carefully to avoid damage.
5. Sweep the condenser with a hand brush or use a vacuum cleaner with brush attachment to clean the fins.
6. Replace the front panel again with care.
7. Fasten the front panel to both columns. Screw the screws on the right and left columns back in.
8. You can switch the device back on.



Alternatively you can vacuum the dust with a vacuum cleaner through the ventilation openings on the front side.

9.5 Cleaning cooling water circuit

This section is relevant for:

- Water-cooled devices

Cleaning filter strainer

The cooling water circuit and filter strainer must be cleaned regularly to maintain full cooling output.

- Protective equipment:
- Safety glasses
 - Protective gloves
 - Protective work clothing

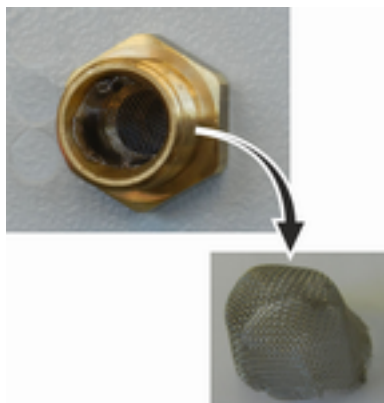

Fig. 85: Remove filter strainer

1. Switch machine off.
2. Shut down cooling water supply.
3. Unscrew the hose for the cooling water inlet from the device.
4. Remove the filter strainer from the water inlet. If necessary, use pointed pliers or large tweezers.
5. Clean the filter strainer.
6. Replace cleaned filter strainer and reconnect the hose.

Descal cooling water circuit

Required equipment for descaling with a pump (drum pump):

- a container with approx 20 liter volume
- a pump
- Hoses between container and pump and between pump and cooling water circuit
- Hose between cooling water circuit and container

Required equipment for descaling with a funnel:

- Two containers with 10 to 20 liter volume
- A funnel
- Hose between funnel and cooling water circuit Place the funnel as high as possible, so that the device fills with descaler quickly.
- Hose between cooling water circuit and container

Protective equipment: ■ Safety glasses
 ■ Protective gloves
 ■ Protective work clothing

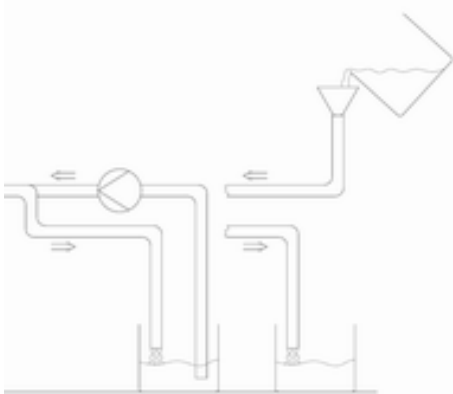

Fig. 86: Descaling

1. Switch the device into standby.
2. Press the Enter key to open the menu.
3. Select the menu items → *Fill mode* → *Water valve* → *open* on the operating unit.
 - ▶ The water valve opens.
4. Fill the device with descaler-water mixture via the hose on the cooling water inlet.
5. Recirculate the descaler/water mixture or refill continuously.
6. Leave the descaler-water mixture to work (see table below).
7. Flush the device thoroughly with clean water (see table below).
8. Drain cooling water circuit Blow compressed air through the cooling water circuit.
9. Select the menu items → *Fill mode* → *Water valve* → *auto* (automatic) on the operating unit. This is the default setting.

Reaction time:	Continue pumping or refilling until the foaming reaction (usually at the beginning) has subsided. This usually takes 15 to 30 minutes.
Descaler:	Only permitted: LAUDA descaler with article number LZB 126 (5 kg pack). You must always follow the safety instructions and the instructions for use on the packaging when handling the chemical!
Flushing:	Let at least 30 liters of clean water run through the device.

9.6 Checking the overtemperature protection

The device must switch off if the temperature of the heat transfer liquid exceeds the overtemperature switch-off points T_{max} and/or $T_{maxTank}$. The electronics system switches off the device components.



Fig. 87: Display Tmax



Fig. 88: Enter Tmax

1. Press and hold down the T_{max} key ↵ Chapter 6.4 “Setting Tmax” on page 88.
 - ▶ The values T_{max} and $T_{maxTank}$ appear on the display.
2. With the arrow keys select the T_{max} value, while keeping the T_{max} key pressed down.
3. Press the Enter key.
 - ▶ The entry window appears. The cursor flashes under the T_{max} value.

4. Use the arrow keys to set a value that is a few °C above the set temperature T_{set} .



If you release the T_{max} key the process is aborted.

5. Press the [OK] to confirm the new value.
6. Press [ANW] softkey to confirm the new value.
 - ▶ The new value is active.
7. Now set the set temperature T_{set} higher than the overtemperature switch-off point T_{max} . Press [OK] to confirm the set temperature.
 - ▶ The device heats up. The device switches off when the overtemperature switch-off point is exceeded. A fault is displayed.
8. Using the T_{max} key, set the correct T_{max} value again.
 - ▶ In the display the set T_{max} value is displayed.
9. Delete the fault in the device menu.

9.7 Checking the low-level protection

An alarm signal sounds before the liquid level decreases so much that the heater is no longer covered completely with liquid. *Low level* appears on the display. The electronics system switches off the device components.



WARNING!
Contact with hot or cold heat transfer liquid

Scalding, cold burns

- Bring the heat transfer liquid to room temperature before draining.



An alarm must sound as soon as the minimum level is reached.

- Personnel: ■ Operating personnel
- Protective equipment: ■ Safety glasses
 ■ Protective gloves
 ■ Protective work clothing

1. Switch on the device and the pump. Set the set temperature to room temperature.
2. Watch the level indication on the display.
3. Lower the liquid level in the device. For this purpose, allow the heat transfer liquid to flow out into a suitable container via the open drain nozzle.
 - ▶ The display shows that the heat transfer liquid is sinking.
 - If the fill level falls to level 2, a warning is issued on the display.
 - If the liquid falls to level 0, the device switches off and the *Alarm* message appears on the display.
4. Close the drain tap.
5. Top up the heat transfer liquid.
 - ▶ The liquid level in the display rises.
6. Delete the fault in the device menu.

9.8 Check the heat transfer liquid

- Protective equipment: ■ Safety glasses
 ■ Protective gloves
 ■ Protective work clothing

	CAUTION! Contact with hot/cold heat transfer liquid
	Scalding, cold burns
	<ul style="list-style-type: none"> ● Bring the heat transfer liquid to room temperature for analysis.

Heat transfer liquid is subject to wear, such as cracking or aging (oxidation). If necessary, the heat transfer liquid (e.g. if the operating mode is changed), but at least every six months, must be checked for usability. Continued use of the heat transfer liquid is only permitted following successful testing.

The heat transfer liquid must be tested as outlined in DIN 51529: Testing and assessment of used heat carrier media.

Source: VDI 3033; DIN 51529

10 Faults

10.1 Alarms, errors and warnings

All alarms, error messages and warnings triggered on the device appear in text form on the display.

Procedure in event of alarm

Alarms affect safety. The components of the device, such as the pump, switch off. The device emits a sound. Once the cause of the fault has been eliminated, the alarm can be canceled with the Enter key.

Refer to  Chapter 10.2 “Alarms” on page 151 for a list of alarms.

Procedure in event of warning

Warnings do not have a significant effect on safety. The device continues to operate. The device will make a continuous noise for a short period of time. Warnings are issued periodically. Once the cause of the fault has been eliminated, the warning can be canceled with the Enter key.

Procedure in event of error

If an error occurs, the device emits a sound.

If this happens, switch off the device at the mains switch. If the error occurs again after switching on the device, make a note of the error code and the corresponding description and contact the LAUDA Constant Temperature Equipment Service department. You will find the contact information here  Chapter 14.5 “Contact LAUDA” on page 165.



Errors are displayed with an appropriate description and an error code in the form of a consecutive number.

10.2 Alarms



Alarms are shown on all displays in use.

Table 44: Constant temperature equipment alarms

Code	Message	Description	User action
1	Low-level pump	Pump detects low level	Refilling the heat transfer liquid
2	Low level	Float detects low level	Refilling the heat transfer liquid
3	Overtemperature	Overtemperature ($T > T_{max}$)	Allow the device to cool down to $T < T_{max}$; adjust T_{max} if necessary
4	Pump blocked	Standstill of the pump	Switch off the device, check the viscosity
5	Verb. Command	Command Touch remote control withdrawn during operation.	Plug in the cable of the Command Touch remote control unit.
6	---	---	----

Code	Message	Description	User action
7	No water	No cooling water connected	Provide a supply of cooling water
8	---	---	---
9	T ext Pt100	No actual value from the Pt100 module	Check the temperature probe
10	T ext analog	No actual value from the analog interface	Check the temperature probe
11	T ext serial	No actual value from the serial interface	Check the serial connection
12	Analog input 1	Analog module: Current interface 1, interruption.	Check the connection
13	Analog input 2	Analog module: Current interface 2, interruption.	Check the connection
14	High level	Float detects high level	Drain excess heat transfer liquid from the device. Caution: risk of burns
15	Digital input	Interference signal at the input of the contact module	(customer application)
16	Refilling	Heat transfer liquid level is too low	Refilling the heat transfer liquid
19	Gage pressure	Gage pressure in the outflow	Reduce/eliminate the hydraulic resistance in the hoses or/and in the consumer
20	T ext Ethernet	No actual value from the Ethernet interface	Check the serial connection Check whether the control station specifies the actual temperature via the Ethernet interface
22	Communication interrupted	Connection to the control station interrupted	Check the cable connection
23	T ext EtherCAT	No actual value from the EtherCAT interface	Check the serial connection
24	Overtemperature	Overtemperature in expansion vessel ($T > T_{maxTank}$) Overtemperature in devices with pressure overlay ($T > T_{max_Return}$)	Allow the device to cool down

Table 45: Flow Controller Alarms

Code	Message	Description	User action
55	Flow meter timeout	Error in the LiBus cable connection	<ul style="list-style-type: none"> ■ Switch off the constant temperature equipment ■ Check the LiBus cable connection and restore if necessary ■ Switching the constant temperature equipment on

10.3 Troubleshooting

Before informing the LAUDA Service department, please check whether you can solve the problem with the following instructions.

Table 46: Process thermostat

Fault	Cause ⇒ Possible remedy
The device cools very slowly or not at all.	<ul style="list-style-type: none"> ■ The cooling unit is switched off ⇒ switch on the cooling unit. ■ The controller output limit is active ⇒ Switch off the controller output limit. ■ The condenser is contaminated ⇒ Clean the condenser ↪ Chapter 9.4 “Cleaning the air-cooled condenser” on page 146. ■ The temperature limit value Til is too high ⇒ Reduce the temperature limit value Til.
The device heats only very slightly or not at all.	<ul style="list-style-type: none"> ■ The controller output limit is active ⇒ Switch off the controller output limit. ■ The temperature limit value Til is too low ⇒ Increase the temperature limit value Til. ■ The dynamic heating output restriction is active ⇒ switch off the dynamic heating output restriction. ■ The maximum heating output is automatically reduced in the lower pump levels ⇒ increase the pump level. ■ The maximum current consumption of the device is limited ⇒ increase the current consumption.
Pump level cannot be set.	<ul style="list-style-type: none"> ■ Pressure control is active ⇒ switch off pressure control (pressure control is switched off if set pressure = 0 bar).
Degassing functions poorly.	<ul style="list-style-type: none"> ■ Pressure control is active ⇒ switch off the pressure control. ■ Pump level is too high ⇒ select a lower pump level. ■ Heating output is too high ⇒ reduce the heating output. ■ Cooling unit is active ⇒ switch off cooling unit. ■ Heat transfer liquid is heavily contaminated ⇒ change the heat transfer liquid. Empty the device completely and carry out internal cleaning of the device if required. ■ The filler nozzle is closed ⇒ remove the tank lid and place it loosely on the filler nozzle. ■ IN 2560 XTW: Connect the inert gas blanket, with compressed air for pure degassing if necessary.
Cooling unit starts several times in quick succession	<ul style="list-style-type: none"> ■ Normal function (special start), no remedy necessary
The cooling unit is in operation for a few minutes, although no cooling is necessary.	<ul style="list-style-type: none"> ■ Normal function (protection function), no remedy necessary

Fault	Cause ⇒ Possible remedy
Display: Low flow (cooling unit). (Flow in the evaporator area too low)	<ul style="list-style-type: none"> ■ Check whether the hydraulic circuit is blocked (closed valves, jammed hose, dirt,...). ⇒ remedy the cause. ■ Pump level is too low ⇒ select a higher pump level. ■ Hose cross-section too small ⇒ increase the cross-section or install a bypass. ■ Cooling output is too high for the available flow rate ⇒ reduce the cooling output.
Display: Low flow (heater) (Flow in the heater area too low).	<ul style="list-style-type: none"> ■ Check whether the hydraulic circuit is blocked (closed valves, jammed hose, dirt,...). ⇒ remedy the cause. ■ Pump level is too low ⇒ select a higher pump level. ■ The device is not sufficiently aerated or degassed ⇒ degas the device again. ■ Hose cross-section too small ⇒ increase the cross-section or install a bypass. ■ Heating output is too high for the available flow rate ⇒ reduce the heating output.
Display: Overtemperature protection	<ul style="list-style-type: none"> ■ Wait until the outflow temperature has cooled below the overtemperature switch-off point or set the switch-off point higher than the outflow temperature.
Display: Level very low (Impending low level in expansion vessel) Display: Low level (Low level in expansion vessel)	<ul style="list-style-type: none"> ■ Check hoses, connections and consumers for leaky points (leaks) ⇒ if necessary, eliminate the leakage and top up the missing heat transfer liquid. ■ Check the constant temperature equipment as to whether there is a leaky point (leak) ⇒ if necessary inform the LAUDA Service department ↪ Chapter 14.5 “Contact LAUDA” on page 165 ■ The liquid level can drop due to cooling or degassing ⇒ if necessary refill the missing heat transfer liquid.
Display: Level too high (Impending high level in expansion vessel). Display: Level too high (High level in expansion vessel).	<ul style="list-style-type: none"> ■ heating increases the volume ■ the heat transfer liquid has absorbed moisture from the ambient air
Display: Pump blocked (Pump motor monitoring: overload, blockage).	<ul style="list-style-type: none"> ■ The viscosity of the heat transfer liquid is too high ⇒ change to another heat transfer liquid or increase the set temperature. ■ The pump is blocked ⇒ inform the LAUDA Service department ↪ Chapter 14.5 “Contact LAUDA” on page 165
Display: Low level (pump) (Pump motor monitoring: idling).	<ul style="list-style-type: none"> ■ No liquid in system. If this is the case, the level monitoring has failed. ⇒ Check whether the float in the expansion vessel is blocked by a foreign object. If not, notify the LAUDA Service ↪ Chapter 14.5 “Contact LAUDA” on page 165 department.

Fault	Cause ⇒ Possible remedy
Display: Gage pressure (Outflow pressure too high)	<ul style="list-style-type: none"> ■ Pump level is too high ⇒ select a lower pump level. ■ When pressure control is active, the set pressure is too high ⇒ reduce the set pressure. ■ The maximum pressure is too low ⇒ increase the maximum pressure, but only if your application, hoses, etc. cannot be damaged.
Display: Evaporator frozen	<ul style="list-style-type: none"> ■ Increase the pump level. ■ Open the manual bypass in the constant temperature equipment. ■ Increase the flow rate through the application.
Unstable temperature control (Temperature fluctuates strongly)	<ul style="list-style-type: none"> ■ Increase the pump level. ■ Open the manual bypass in the constant temperature equipment. ■ If necessary, increase the control parameters X_p and T_n. ■ Increase the flow rate through the application. ■ Reduce the load.

Table 47: High-temperature thermostat

Fault	Possible remedy
<p>Alarm Cool Flow in the display</p> <ul style="list-style-type: none"> ■ Cooling water temperature is higher than 80°C and for longer than 8 seconds. ■ Cooling water temperature is higher than 85 °C. <p>Warning HT valve too hot in the display</p> <ul style="list-style-type: none"> ■ Temperature on high-temperature valve is higher than 120 °C and for longer than 8 seconds. ■ Temperature on high-temperature valve is higher than 140 °C. <p>Consequence: Irreversible damage to the high-temperature valve</p> <p>Possible cause</p> <ul style="list-style-type: none"> ■ Pressure fluctuations of the cooling water ■ Accidental disconnection of the cooling water by third parties ■ Blockage of high-temperature valve ■ Breakage of the piping on the device side for the cooling water 	<ul style="list-style-type: none"> ■ Turn water connection on full ⇔ Restore a correct cooling water supply. ■ In the event of a blockage of the high-temperature valve, inform the LAUDA Service ⇨ Chapter 14.5 “Contact LAUDA” on page 165.
<p>Device switches to degas mode ⇨ Chapter 5.6 “Degas heat transfer liquid (low boiling point expulsion)” on page 76.</p> <p>Possible cause:</p> <ul style="list-style-type: none"> ■ Cooling water enters the hydraulic circuit through a defective heat exchanger. <p>However, it is to be noted: If necessary, the device carries out "automatic degassing". This automatic process is no fault.</p>	<ul style="list-style-type: none"> ■ Notify the LAUDA Service ⇨ Chapter 14.5 “Contact LAUDA” on page 165 department. ■ Ensure the suitable cooling water quality ⇨ Chapter 4.5 “Cooling water requirements” on page 41. Otherwise there is a risk of corrosion!

11 Decommissioning

11.1 Information on decommissioning



WARNING!
Contact with hot or cold heat transfer liquid

Scalding, cold burns

- Bring the heat transfer liquid to room temperature before draining.



NOTICE!
Risk of refrigerant escaping from cooling water circuit

Device damage

- Before decommissioning the device or if there is a risk of freezing, drain the cooling water circuit of the cooling unit using compressed air or an industrial vacuum cleaner (watertight). Blow compressed air through the circuit.

Protective equipment: ■ Safety glasses
■ Protective gloves
■ Protective work clothing

To avoid damage during storage, all liquids must be drained completely from the device.

1. Drain the heat transfer liquid from the device.
2. Drain the cooling water from water-cooled devices.
3. Store the device, maintain the storage temperatures ↪ Chapter 15.1 "General data" on page 166.

11.2 Drain and clean the device

Draining the device



Do not drain the heat transfer liquid in a hot state above 90°C or in a cold state below 0°C!



Observe the regulations for the disposal of used heat transfer liquid.
↪ Chapter 4.4 "LAUDA heat transfer liquids" on page 39,
↪ Chapter 12.4 "Disposing of heat transfer liquid and liquids" on page 162

↪ "Draining the high-temperature thermostat" on page 158

- Protective equipment:
- Safety glasses
 - Protective gloves
 - Protective work clothing

The drain taps and drain nozzles are located on the right hand side of all devices.

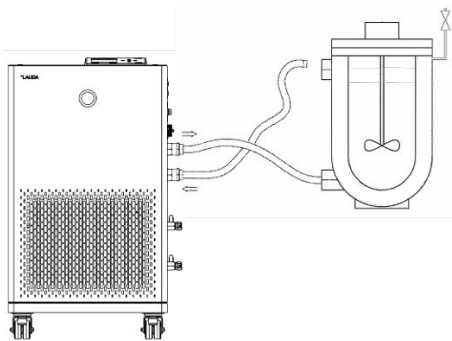

Fig. 89

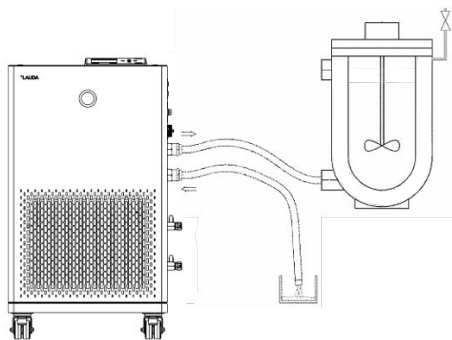

Fig. 90

Draining the high-temperature thermostat

1. Allow the device and heat transfer liquid to cool or warm up to room temperature.
2. Screw the hose nozzle with a union nut (EOA 078) onto the drain nozzle (3/8" exterior thread). There are two drain nozzles from the Integral 550 XT and higher.

3. Insert a hose on the hose nozzle for draining. Place the hose in a suitable container to collect the heat transfer liquid.



It may be necessary to drain the device several times if the filling volume is high.

4. Open the drain tap. To do this, turn the tap counterclockwise.
5. Allow the device to run empty.

6. After the device has run empty, remove the hoses from the external consumers. Drain the heat transfer liquid in the hoses into a suitable container.
7. After draining close the drain tap or taps.

The high-temperature thermostat is in standby mode.

1. Screw the hose nozzle with a union nut (EOA 078) onto the drain nozzle (3/8" exterior thread).
2. Insert a hose on the hose nozzle for draining. Place the hose in a suitable container to collect the heat transfer liquid.
3. Press the Enter key to open the menu.
4. Select the menu items → *Fill mode* → *Drain* → *on off*.
 - ▶ The high-temperature valve in the device is set in such a way that the bypass line also runs empty.
5. Allow the device to run empty.
6. Select the menu items → *Fill mode* → *Drain* → *off off*.
 - ▶ The high-temperature valve closes.

7. After draining, close the drain tap or taps.

Internal cleaning

After the heat transfer liquid has been drained, residues remain in the device. These residues must be removed to avoid deposits in the device during storage.

If new heat transfer liquid is added and the device is operated above the thermal load limit for the old heat transfer liquid, deposits can form, especially on the heaters. These coatings reduce the performance of the device and/or reduce the service life of the device.

Protective equipment: ■ Safety glasses
 ■ Protective gloves
 ■ Protective work clothing

If necessary, clean or flush out the device (with new heat transfer liquid, for example).

If water with a cleaning agent (grease solvent) is used as cleaning liquid, make sure that the device is only operated in fill mode (cooling unit is therefore switched off). Otherwise, there is a risk that the device may freeze internally and become damaged as a result.

1. Connect a hose to the pump connectors (short circuit between the outflow connector and the return connector).
2. Fill the device with a suitable cleaning fluid. During this time, operate the device in fill mode.
3. Drain the device via the drain connector.
4. Check the cleaning fluid for dirt and the remains of old heat transfer liquid.
 - ▶ If you detect dirt in the cleaning fluid, repeat points 2 to 3. Otherwise continue with point 5.
5. Remove hose from the pump connector.
6. Dry the hydraulic circuit in the device with compressed air.

To do this, carefully allow the compressed air to flow into the device alternately via the outflow and return connectors.



If the device has been cleaned with a highly oil-soluble liquid (e.g. ethanol), do not leave it dry for longer periods (1 day) or transport it, as the pump requires a minimum lubrication.

Table 48: Cleaning fluids

Suitable cleaning fluid	for heat transfer liquid
Ethanol (solvent) <i>It is essential to observe the relevant safety measures for handling ethanol!</i>	Kryo 20 Kryo 51 Kryo 65 Kryo 70 Kryo 95 Ultra 350
Water	Kryo 30

11.3 Draining the cooling water circuit

This section is relevant for:

- Water-cooled devices

To avoid damage during storage, the cooling water circuit on water-cooled devices must be drained completely.

Protective equipment: ■ Safety glasses
 ■ Protective gloves
 ■ Protective work clothing

The device is now in standby mode.

1. Shut down cooling water supply.
2. Unscrew the hose for the cooling water inlet from the device.
3. Remove the filter strainer from the water inlet. If necessary, use pointed pliers or large tweezers.
4. Clean the filter strainer.
5. Press the Enter key to open the menu.
6. Select the menu items → *Fill mode* → *Water valve* → *open* on the operating unit.
 - ▶ The water valve opens.
7. Drain the cooling water circuit completely.
8. Select the menu items → *Fill mode* → *Water valve* → *auto* (automatic) on the operating unit. This is the default setting.
9. Place the cleaned filter screen back into the water inlet.

12 Disposal

12.1 Disposing of packaging

The following applies for EU member states: Disposal of the packaging must proceed according to regulation 94/62/EC.

12.2 Disposing of refrigerant

Disposal of refrigerant must proceed according to regulation 2015/2067/EU in combination with regulation 517/2014/EU.



CAUTION!
Uncontrolled escape of refrigerant

Impacts, cutting

- Only specialized personnel are permitted to perform disposal work.



NOTICE!
Uncontrolled escape of refrigerant

Environment

- Never dispose of a cooling circuit that is still pressurized.
- Only specialized personnel are permitted to perform disposal work.



The type and refrigerant charge are printed on the rating label.

Have repair and disposal carried out only by a refrigeration technician.

12.3 Device disposal



The following applies for EU member states: The device must be disposed of according to Directive 2012/19/EU (WEEE Waste of Electrical and Electronic Equipment).

12.4 Disposing of heat transfer liquid and liquids

Information on the disposal of heat transfer liquid and other liquids (e.g. ethanol):

- Liquids must be disposed of in accordance with the official regulations.
- Refer to the relevant safety data sheet for the liquid for information on correct disposal.
The link to the LAUDA safety data sheets can be found in ↗ Chapter 4.4 “LAUDA heat transfer liquids” on page 39.
- Use the original containers of the liquids when transporting them for disposal.

13 Accessories

The following optional accessories are available for the Integral devices.

Table 49: Module bay 51 mm x 27 mm

Accessories	Catalog number
Analog interface module	LRZ 912
RS 232/485-interface module Advanced	LRZ 926
Contact interface module Advanced with 1 input and 1 output	LRZ 927
Contact interface module Advanced with 3 inputs and 3 outputs	LRZ 928
Profibus interface module Advanced	LRZ 929
EtherCAT interface module, M8 socket connection	LRZ 922
EtherCAT interface module, RJ45 socket connection	LRZ 923
Pt100 LiBus interface module	LRZ 925
Profinet interface module Advanced	LRZ 932
CAN interface module Advanced	LRZ 933

Table 50: Connecting plug

Accessories	Catalog number
External temperature probe with socket and shielded connection cable	ETP 059
Coupling connector, 6-pin for analog inputs/outputs	EQS 057
Connecting plug SUB-D, 9-pin	EQM 042
RS 232 cable (length: 2 m) for PC	EKS 037
RS 232 cable (length: 5 m) for PC	EKS 057
3-pin coupling connector for contact input	EQS 048
3-pin coupling socket for contact output	EQD 047

Accessories	Suitable for	Catalog number
Command Touch remote control unit	All devices	LRT 923
Flow controller	Integral IN XT	L003217

Please also refer to our accessory brochure for further accessories.

14 General

14.1 Copyright

This manual is protected by copyright and only meant for internal use by purchasers.

The relinquishment of this manual to third parties, copying in any way whatsoever – even in the form of excerpts – and the utilization and/or conveyance of its content are not allowed, except for internal purposes, without written approval from the manufacturer.

Violation of this may obligate the violator to the payment of damages. Other claims reserved.

We point out that the designations and brand names of the respective companies used in the manual are generally subject to trademark, brand and patent protection.

14.2 Technical changes

The manufacturer reserves the right to make technical modifications to the device.

14.3 Warranty conditions

LAUDA offers a standard 12 month manufacturer's warranty on Integral process thermostats from the date of purchase.

14.4 License texts

You can obtain the license texts for the software used in the device from the English version of our LAUDA website.

1. Enter the following into your browser's address line: <https://www.lauda.de/en/> and confirm your entry.
2. Click → *Services* → *Download center*.
3. In the Download center, chose the [English] option in the [Language] drop-down list.
 - ▶ A long list of files with multiple formats appears.
4. Now also filter the [Software] entry in the [Document type] drop-down list.
 - ▶ The list is now more clear.
5. Search for the following software files:
 - Lizenztexte_µTZ.txt
 - Lizenztexte_Qt.txt
 - GUF-Yocto-31.2-r8616-0.tar.zipClick on the relevant file line to start the download.
 - ▶ The file starts downloading.

14.5 Contact LAUDA

Contact the LAUDA Service in the following cases:

- Troubleshooting
- Technical questions
- Ordering accessories and spare parts

Please contact our sales department for questions relating to your specific application.

Contact information

LAUDA Service

Phone: +49 (0)9343 503-350

Email: service@lauda.de

15 Technical data

15.1 General data

Specification	Value	Unit
Display type	TFT, white font on black background	---
Display size	3.5	Inches
Display resolution	320 x 240	Pixels
Setting resolution	0.01	°C
Display resolution	0.01	°C
Display accuracy, internal/outflow	±0.2	°C
Entry	via eight keys	---
Installation and use	Indoors	---
Use up to a maximum height above sea level of	2000	m
Relative humidity	Maximum relative humidity 80% at an ambient temperature of 31°C, relative humidity linearly decreasing to 50% at 40°C.	---
Mains voltage fluctuations	Permissible up to ±10% of the nominal voltage	---
Protection level (IP code) according to IEC 60529	IP 21	---
Degree of pollution according to EN 60664-1 / VDE 0110-1	Pollution degree 2 Only <u>non-conductive</u> pollution occurs in the device. However, temporary conductivity due to condensation must be expected occasionally.	---
Protection class for electrical equipment DIN EN 61140 (VDE 0140-1)	1	---
Class division according to DIN 12876-1	(not valid for pressurized devices P _h “Pressurized devices P” on page 170)	
- Class designation	III	---
- Identification code	FL (suitable for combustible and non-combustible liquids)	---
Temperature range for storage of the device	5 – 43; For water-cooled devices, the condenser must be completely empty	°C
Temperature range for transport of the device	-20 – 43; For water-cooled devices, the condenser must be completely empty	°C
Ambient temperature range	5 – 40	°C



The noise level of the various devices was measured according to the guidelines included in DIN EN ISO 11200 and the basic standards cited therein. The measured values correspond to the operating conditions that occur during typical device operation.

Installation location

- Ensure that adequate ventilation is provided
- Minimum free room volume, room volume per kg of refrigerant according to DIN 378-1
(For refrigerant quantity, see type plate or ↪ Chapter 15.4 “Refrigerant and filling weight” on page 179).

Table 51: Refrigerant and room volume

Refrigerant	Room volume per kg of refrigerant
R-449A	2.81 m ³ /kg
R-452A	2.37 m ³ /kg
R-23	1.48 m ³ /kg
R-508B	4.0 m ³ /kg

Integral T

Table 1	Unit	IN 130 T	IN 230 T	IN 230 TW	IN 530 T
ACC area ①	°C	-30 – 120	-30 – 120	-30 – 120	-30 – 120
Temperature stability ②	K	±0.05	±0.05	±0.05	±0.05
Device dimensions width x depth x height	mm	430 x 550 x 760	430 x 550 x 760	430 x 550 x 760	560 x 550 x 1325
Filling volume					
- minimum	L	3.6	3.6	3.6	7.2
- maximum	L	8.7	8.7	8.7	20.5
Pump data 50 Hz					
- maximum discharge pressure	bar	3.5	3.5	3.5	3.5
- Maximum flow rate	l/min	40	40	40	40.0
Pump data 60 Hz					
- maximum discharge pressure	bar	4.0	4.0	4.0	4.6
- Maximum flow rate	l/min	45	45	45	45
Connector thread (outer) outflow/return flow	Inches	G ³ / ₄ "	G ³ / ₄ "	G ³ / ₄ "	G ³ / ₄ "
Noise level 50 Hz ③	dB(A)	61	63	58	62
Noise level 60 Hz ③	dB(A)	61	63	60	66
Weight	kg	79.0	84.0	85.0	148.5
Distance between device and environment					
- Front	mm	500	500	200	500
- Back	mm	500	500	200	500

Table 1	Unit	IN 130 T	IN 230 T	IN 230 TW	IN 530 T
- Right	mm	500	500	200	500
- Left	mm	500	500	200	500

Table 2	Unit	IN 530 TW	IN 1030 T	IN 1330 TW	IN 1830 TW
ACC area ①	°C	-30 – 120	-30 – 150	-30 – 150	-30 – 150
Temperature stability ②	K	±0.05	±0.1	±0.1	±0.1
Device dimensions width x depth x height	mm	560 x 550 x 1325	760 x 650 x 1605	760 x 650 x 1605	760 x 650 x 1605
Filling volume					
- minimum	L	7.2	9.7	9.7	9.7
- maximum	L	20.5	25.5	25.5	25.5
Pump data 50 Hz					
- maximum discharge pres- sure	bar	3.5	5.5	5.5	5.5
- Maximum flow rate	l/min	40.0	60.0	60.0	60.0
Pump data 60 Hz					
- maximum discharge pres- sure	bar	4.6	7.0	7.0	7.0
- Maximum flow rate	l/min	45	70.0	70.0	70.0
Connector thread (outer) outflow/return flow	inch / mm	G¾"	M38 x 1.5	M38 x 1.5	M38 x 1.5
Noise level 50 Hz ③	dB(A)	62	69	59	64
Noise level 60 Hz ③	dB(A)	64	70	62	67
Weight	kg	149.5	222.5	225.0	231.0
Distance between device and environment					
- Front	mm	200	500	200	200
- Back	mm	200	500	200	200
- Right	mm	200	500	200	200
- Left	mm	200	500	200	200

- ① - ACC area (Active Cooling Control) according to DIN 12876 is the working temperature range during operation with an active cooling unit.
- ② - Temperature stability determined according to standard DIN 12876-2
- ③ - Noise level determined according to standard EN 11201 for operating position in front of the device at 1 meter distance

Integral XT

Table 3	Unit	IN 150 XT	IN 250 XTW	IN 280 XT	IN 280 XTW
ACC area ①	°C	-45 – 220	-45 – 220	-80 – 220	-80 – 220
Temperature stability ②	K	±0.05	±0.05	±0.05	±0.05
Device dimensions width x depth x height	mm	430 x 550 x 760	430 x 550 x 760	560 x 550 x 1325	560 x 550 x 1325
Filling volume					
- minimum	L	2.5	2.5	4.8	4.8
- Maximum	L	8.7	8.7	17.2	17.2
Pump data 50/60 Hz					
- maximum discharge pres- sure	bar	3.1	3.1	3.1	3.1
- Maximum flow rate	l/min	65.0	65.0	65.0	65.0
Connector thread (outer) outflow/return flow	mm	M30 x 1.5	M30 x 1.5	M30 x 1.5	M30 x 1.5
Noise level 50 Hz ③	dB(A)	60	57	62	60
Noise level 60 Hz ③	dB(A)	60	57	63	62
Weight	kg	102.5	105.5	198.0	194.5
Distance between device and environment					
- Front	mm	500	200	500	200
- Back	mm	500	200	500	200
- Right	mm	500	200	500	200
- Left	mm	500	200	500	200

Table 4	Unit	IN 550 XT	IN 550 XTW	IN 590 XTW	IN 750 XT
ACC area ①	°C	-50 – 220	-50 – 220	-90 – 220	-45 – 220
Temperature stability ②	K	±0.05	±0.05	±0.05	±0.05
Device dimensions width x depth x height	mm	560 x 550 x 1325	560 x 550 x 1325	760 x 650 x 1605	560 x 550 x 1325
Filling volume					
- minimum	L	4.8	4.8	8.0	4.8
- Maximum	L	17.2	17.2	28.6	17.2
Pump data 50/60 Hz					
- maximum discharge pres- sure	bar	3.1	3.1	3.1	3.1
- Maximum flow rate	l/min	65.0	65.0	65.0	65.0
Connector thread (outer) outflow/return flow	mm	M30 x 1.5	M30 x 1.5	M30 x 1.5	M30 x 1.5
Noise level 50 Hz ③	dB(A)	65	64	62	66

Table 4	Unit	IN 550 XT	IN 550 XTW	IN 590 XTW	IN 750 XT
Noise level 60 Hz ③	dB(A)	66	66	66	68
Weight	kg	176.5	176.5	279.0	175.5
Distance between device and environment					
- Front	mm	500	200	200	500
- Back	mm	500	200	200	500
- Right	mm	500	200	200	500
- Left	mm	500	200	200	500

Table 5	Unit	IN 950 XTW	IN 1590 XTW	IN 1850 XTW	IN 2560 XTW
ACC area ①	°C	-50 – 220	-90 – 220	-50 – 220	-60 – 220
Temperature stability ②	K	±0.05	±0.05	±0.05	±0.1
Device dimensions width x depth x height	mm	560 x 550 x 1325	760 x 650 x 1605	760 x 650 x 1605	1100 x 895 x 1865
Filling volume					
- minimum	L	4.8	10.0	8.0	12.6
- Maximum	L	17.2	30.6	28.6	34.4
Pump data 50/60 Hz					
- maximum discharge pressure	bar	3.1	3.1	6.0	6.0
- Maximum flow rate	l/min	65.0	65.0	120.0	100.0
Connector thread (outer) outflow/return flow	mm	M30 x 1.5	M38 x 1.5	M38 x 1.5	M38 x 1.5
Noise level 50 Hz ③	dB(A)	67	63	62	72
Noise level 60 Hz ③	dB(A)	69	65	62	74
Weight	kg	176.0	356.0	287.5	615.0
Distance between device and environment					
- Front	mm	200	200	200	200
- Back	mm	200	200	200	200
- Right	mm	200	200	200	200
- Left	mm	200	200	200	200

Pressurized devices P

Table 6	Unit	IN 2050 PW	IN 2560 PW
ACC area ①	°C	-40 – 140	-40 – 140
Temperature stability ②	K	±0.05	±0.1
Device dimensions width x depth x height	mm	1100 x 895 x 1865	1100 x 895 x 1865

Table 6	Unit	IN 2050 PW	IN 2560 PW
Filling volume			
- minimum	L	11.1	12.1
- Maximum	L	36.3	48.1
Pump data 50/60 Hz			
- maximum discharge pressure	bar	6.0	6.0
- Maximum flow rate	l/min	120.0	100.0
Connector thread (outer) outflow/return flow	mm	M38 x 1.5	M38 x 1.5
Noise level 50 Hz ③	dB(A)	58	74
Noise level 60 Hz ③	dB(A)	58	74
Weight	kg	382.0	647.0
Distance between device and environment			
- Front	mm	200	200
- Back	mm	200	200
- Right	mm	200	200
- Left	mm	200	200
Class division according to DIN 12 876-1			
- Class designation	---	I	I
- Identification code	---	NFL (suitable for non-flammable liquids)	NFL (suitable for non-flammable liquids)

- ① - ACC area (Active Cooling Control) according to DIN 12876 is the working temperature range during operation with an active cooling unit.
- ② - Temperature stability determined according to standard DIN 12876-2
- ③ - Noise level determined according to standard EN 11201 for operating position in front of the device at 1 meter distance

15.2 Heating output and power supply

If the maximum current consumption is limited ↘ “Limiting the current consumption” on page 96 the heating output can be reduced.

Depending on the country-specific version, the maximum current consumption may already be limited ex works. Limited current consumption values are shown in brackets.

Integral T

Table 1	Unit	IN 130 T	IN 230 T	IN 230 TW
Heating output				
230 V; 50 Hz	kW	2.7	2.7	2.7
200 V; 50/60 Hz	kW	2.2	2.2	2.2

Table 1	Unit	IN 130 T	IN 230 T	IN 230 TW
208-220 V; 60 Hz	kW	2.4 – 2.6	2.4 – 2.6	2.4 – 2.6
Current consumption	A	16.0 (13.0)	16.0 (13.0)	16.0 (13.0)

Table 2	Unit	IN 530 T	IN 530 TW	IN 1030 T	IN 1330 TW	IN 1830 TW
Heating output 400 V; 3/PE; 50 Hz & 460 V; 3/PE; 60 Hz	kW	8.0	8.0	8.0	16.0	16.0
Current consumption	A	16.0	16.0	16.0	25.0	25.0

Integral XT

Table 3	Unit	IN 150 XT	IN 250 XTW	IN 280 XT	IN 280 XTW
Heating output 230 V; 50 Hz	kW	3.5 (2.8)	3.5 (2.8)	---	---
200 V; 50/60 Hz	kW	3.0	3.1	---	---
208-220 V; 60 Hz	kW	3.1 – 3.3	3.2 – 3.4	---	---
400 V; 3/PE; 50 Hz & 460 V; 3/PE; 60 Hz	kW	---	---	4.0	4.0
Current consumption	A	16.0 (13.0)	16.0 (13.0)	13.0	13.0

Table 4	Unit	IN 550 XT	IN 550 XTW	IN 590 XTW	IN 750 XT
Heating output 400 V; 3/PE; 50 Hz & 460 V; 3/PE; 60 Hz	kW	8.0	8.0	8.0	8.0
Current consumption	A	16.0	16.0	16.0	16.0

Table 5	Unit	IN 950 XTW	IN 1590 XTW	IN 1850 XTW	IN 2560 XTW
Heating output 400 V; 3/PE; 50 Hz & 460 V; 3/PE; 60 Hz	kW	8.0	12.0	16.0	24.0
Current consumption	A	16.0	30.0	25.0	60.0

Pressurized devices

Table 6	Unit	IN 2050 PW	IN 2560 PW
Heating output 400 V; 3/PE; 50 Hz & 460 V; 3/PE; 60 Hz	kW	16.0	24.0
Current consumption	A	25.0	60.0

15.3 Cooling output



Measuring the performance data according to DIN 12876

The cooling capacity is measured at fixed temperatures of the heat transfer liquid. Ethanol is used as the standard heat transfer liquid, thermal oil is used for temperatures above 20 °C. The ambient temperature for the measurement of air-cooled devices is 20 °C. For the measurement of water-cooled devices the cooling water temperature is 15 °C as well as the cooling water differential pressure 3 bar.

All water-cooled devices are equipped with the following cooling water connection:

- Exterior thread (male) G ¾ inch

Integral T with air-cooled cooling unit

Table 52: Cooling output

	Unit	IN 130 T	IN 230 T	IN 530 T	IN 1030 T
Cooling output at 100 °C	kW	1.40	2.20	5.00	11.00
20 °C	kW	1.40	2.20	5.00	11.00
10 °C	kW	1.35	1.90	4.50	9.50
0 °C	kW	1.20	1.50	3.80	7.10
-10 °C	kW	0.80	1.00	2.60	4.90
-20 °C	kW	0.40	0.60	1.50	3.00
-30 °C	kW	0.10	0.15	0.60	1.60

Integral T with water-cooled cooling unit

Table 53: Cooling output

	Unit	IN 230 TW	IN 530 TW	IN 1330 TW	IN 1830 TW
Cooling output at (ambient temperature 20 °C)					
100 °C	kW	2.30	6.00	13.00	19.00
20 °C	kW	2.30	6.00	13.00	19.00
10 °C	kW	2.30	5.50	10.00	15.00
0 °C	kW	1.90	4.50	7.60	11.50
-10 °C	kW	1.30	3.00	5.40	7.50
-20 °C	kW	0.75	1.60	3.40	5.00
-30 °C	kW	0.35	0.70	1.70	2.70
Cooling water flow rate	l/min	3.0	14.5	15.5	29.0

	Unit	IN 230 TW	IN 530 TW	IN 1330 TW	IN 1830 TW
Cooling water temperature minimum/maximum	°C	10/30	10/30	10/30	10/30
Recommended cooling water temperature	°C	15	15	15	15
Recommended cooling water pressure difference	bar	3	3	3	3
Minimum cooling water pressure difference*	bar	0.8	0.8	0.8	0.8
Maximum cooling water pressure difference	bar	5	10	10	10
Maximum cooling water pressure	bar	10	10	10	10

* only approved for a max. cooling water temperature of 20 °C

Integral XT with single-stage air-cooled cooling unit

Table 54: Cooling output

	Unit	IN 150 XT	IN 550 XT	IN 750 XT	Pump level
Cooling output at 200 °C	kW	1.50	5.00	7.00	8
100 °C	kW	1.50	5.00	7.00	8
20 °C	kW	1.50	5.00	7.00	8
10 °C	kW	1.50	4.80	7.00	8
0 °C	kW	1.30	4.60	5.40	8
-10 °C	kW	1.00	3.30	3.60	8
-20 °C	kW	0.70	2.30	2.60	4
-30 °C	kW	0.30	1.20	1.60	4
-40 °C	kW	0.06	0.50	0.80	4
-45 °C	kW	0.02	0.22	0.50	2
-50 °C	kW	---	0.10	---	2

Integral XT with single-stage water-cooled cooling unit

Table 55: Cooling output

	Unit	IN 250 XTW	IN 550 XTW	IN 950 XTW	IN 1850 XTW	Pump level
Cooling output at (ambient temperature 20 °C)						
200 °C	kW	2.20	5.80	9.50	20.00	8

	Unit	IN 250 XTW	IN 550 XTW	IN 950 XTW	IN 1850 XTW	Pump level
100 °C	kW	2.20	5.80	9.50	20.00	8
20 °C	kW	2.10	5.80	9.50	20.00	8
10 °C	kW	2.00	5.80	8.50	15.00	8
0 °C	kW	1.80	5.40	6.20	11.50	8
-10 °C	kW	1.40	4.00	4.30	8.50	8
-20 °C	kW	1.00	2.60	3.00	6.10	4
-30 °C	kW	0.55	1.45	1.70	3.60	4
-40 °C	kW	0.20	0.55	0.90	1.90	4
-45 °C	kW	0.05	0.30	0.60	1.30	2
-50 °C	kW	---	0.12	0.35	1.10	2
Cooling water flow rate	l/min	4.2	8.0	20.0	26.0	---
Cooling water temperature minimum/maximum	°C	10/30	10/30	10/30	10/30	---
Recommended cooling water temperature	°C	15	15	15	15	---
Recommended cooling water pressure difference	bar	3	3	3	3	---
Minimum cooling water pressure difference*	bar	0.8	0.8	0.8	0.8	---
Maximum cooling water pressure difference	bar	5	10	10	10	---
Maximum cooling water pressure	bar	10	10	10	10	---

* only approved for a max. cooling water temperature of 20 °C

Table 56: Cooling output

	Unit	IN 2560 XTW	IN 2560 XTW	Pump level
Cooling output (ambient temperature 20 °C)		at 50 Hz	at 60 Hz	
200 °C	kW	25.00	28.00	8
100 °C	kW	25.00	28.00	8
20 °C	kW	25.00	28.00	8
10 °C	kW	24.50	27.50	8
0 °C	kW	22.50	25.50	8
-10 °C	kW	22.00	25.00	8
-20 °C	kW	18.50	21.10	4
-30 °C	kW	12.50	14.90	4

	Unit	IN 2560 XTW	IN 2560 XTW	Pump level
-40 °C	kW	8.70	9.50	4
-50 °C	kW	5.00	5.40	4
-60 °C	kW	3.00	3.30	4
Cooling water flow rate	l/min	29.0	29.0	---
Cooling water temperature minimum/maximum	°C	10/30	10/30	---
Recommended cooling water temperature	°C	15	15	---
Recommended cooling water pressure difference	bar	3	3	---
Minimum cooling water pressure difference*	bar	0.8	0.8	---
Maximum cooling water pressure difference	bar	10	10	---
Maximum cooling water pressure	bar	10	10	---

* only approved for a max. cooling water temperature of 20 °C

Table 57: Cooling output

	Unit	IN 2050 PW	Pump level	IN 2560 PW	IN 2560 PW	Pump level
Cooling output (ambient temperature 20 °C)		at 50/60 Hz		at 50 Hz	at 60 Hz	
140 °C	kW	20.00	8	25.00	28.00	8
100 °C	kW	20.00	8	25.00	28.00	8
20 °C	kW	20.00	8	25.00	28.00	8
10 °C	kW	15.00	8	25.00	28.00	8
0 °C	kW	10.80	8	24.50	27.50	8
-10 °C	kW	7.80	8	24.00	27.00	8
-20 °C	kW	4.80	4	17.70	19.0	8
-30 °C	kW	3.00	4	11.0	12.0	8
-40 °C	kW	1.60	4	7.5	7.7	8
Cooling water flow rate	l/min	26.0	---	29.0	29.0	---
Cooling water temperature minimum/maximum	°C	10/30	---	10/30	10/30	---

	Unit	IN 2050 PW	Pump level	IN 2560 PW	IN 2560 PW	Pump level
Recommended cooling water temperature	°C	15	---	15	15	---
Recommended cooling water pressure difference	bar	3	---	3	3	---
Minimum cooling water pressure difference*	bar	0.8	---	0.8	0.8	---
Maximum cooling water pressure difference	bar	10	---	10	10	---
Maximum cooling water pressure	bar	10	---	10	10	---

* only approved for a max. cooling water temperature of 20 °C

Integral XT with two-stage cooling unit

Table 58: Cooling output

	Unit	IN 280 XT	IN 280 XTW	IN 590 XTW	Pump level
Cooling output at (ambient temperature 20 °C)					
200 °C	kW	1.60	1.70	4.50	8
100 °C	kW	1.60	1.70	4.50	8
20 °C	kW	1.60	1.70	4.50	8
10 °C	kW	1.55	1.65	4.45	8
0 °C	kW	1.50	1.60	4.40	8
-10 °C	kW	1.50	1.60	4.40	8
-20 °C	kW	1.70	1.80	4.60	4
-30 °C	kW	1.70	1.80	4.60	4
-40 °C	kW	1.65	1.80	4.50	4
-50 °C	kW	1.40	1.50	4.20	4
-60 °C	kW	0.85	0.90	2.70	4
-70 °C	kW	0.35	0.45	1.40	4
-80 °C	kW	0.15	0.18	0.60 ^①	2
-90 °C	kW	---	---	0.20	2
Cooling medium	---	Air	Water	Water	---
Cooling water flow rate	l/min	---	2.7	15.8	---
Cooling water temperature minimum/maximum	°C	---	10/30	10/30	---

	Unit	IN 280 XT	IN 280 XTW	IN 590 XTW	Pump level
Recommended cooling water temperature	°C	---	15	15	---
Recommended cooling water pressure difference	bar	---	3	3	---
Minimum differential pressure of cooling water ^②	bar	---	0.8	0.8	---
Maximum cooling water pressure difference	bar	---	5	10	---
Maximum cooling water pressure	bar	---	10	10	---
① Pump level 4					
② only approved for a max. cooling water temperature of 20 °C					

Table 59: Cooling output

	Unit	IN 1590 XTW	IN 1590 XTW	Pump level
Cooling output at (ambient temperature 20 °C)		at 50 Hz	at 60 Hz	
200 °C	kW	18.50	18.50	8
100 °C	kW	18.50	18.50	8
20 °C	kW	18.50	18.50	8
10 °C	kW	15.00	16.00	8
0 °C	kW	11.50	12.20	8
-10 °C	kW	8.70	9.00	8
-20 °C	kW	8.50	9.00	4
-30 °C	kW	8.50	9.00	4
-40 °C	kW	7.50	8.50	4
-50 °C	kW	6.00	7.00	4
-60 °C	kW	4.00	5.20	4
-70 °C	kW	2.20	3.40	4
-80 °C	kW	0.90	1.50	4
-90 °C	kW	0.35	0.50	2
Cooling medium	---	Water	Water	---
Cooling water flow rate	l/min	26.0	26.0	---
Cooling water temperature minimum/maximum	°C	10/30	10/30	---
Recommended cooling water temperature	°C	15	15	---

	Unit	IN 1590 XTW	IN 1590 XTW	Pump level
Recommended cooling water pressure difference	bar	3	3	---
Minimum cooling water pressure difference*	bar	0.8	0.8	---
Maximum cooling water pressure difference	bar	10	10	---
Maximum cooling water pressure	bar	10	10	---

* only approved for a max. cooling water temperature of 20 °C

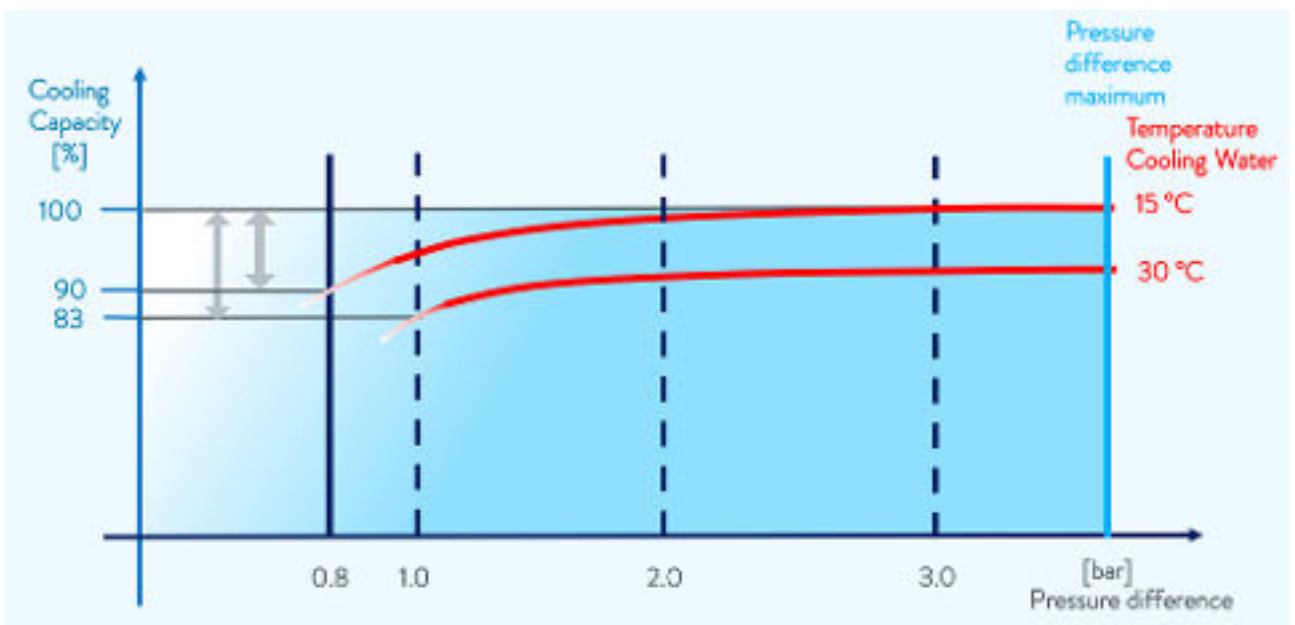

Fig. 91: Cooling water pressure difference

15.4 Refrigerant and filling weight

The device contains fluorinated greenhouse gases.

Integral T

Table 1	Unit	IN 130 T	IN 230 T	IN 230 TW	IN 530 T
Refrigerant	---	R-449A	R-449A	R-449A	R-449A
Maximum filling weight	kg	0.40	0.45	0.45	1.20
GWP _(100a) *	---	1397	1397	1397	1397
CO ₂ equivalent	t	0.6	0.6	0.6	1.7

Table 2	Unit	IN 530 TW	IN 1030 T	IN 1330 TW	IN 1830 TW
Refrigerant	---	R-449A	R-449A	R-449A	R-449A
Maximum filling weight	kg	1.20	2.00	2.20	2.20

Table 2	Unit	IN 530 TW	IN 1030 T	IN 1330 TW	IN 1830 TW
GWP _(100a) *	---	1397	1397	1397	1397
CO ₂ equivalent	t	1.7	2.8	3.1	3.1

Integral XT with single-stage cooling unit

Table 3	Unit	IN 150 XT	IN 250 XTW	IN 550 XT	IN 550 XTW
Refrigerant	---	R-449A	R-449A	R-452A	R-452A
Maximum filling weight	kg	0.40	0.45	1.55	1.55
GWP _(100a) *	---	1397	1397	2140	2140
CO ₂ equivalent	t	0.6	0.6	3.3	3.3

Table 4	Unit	IN 750 XT	IN 950 XTW	IN 1850 XTW	IN 2560 XTW
Refrigerant	---	R-449A	R-449A	R-449A	R-449A
Maximum filling weight	kg	1.80	1.80	2.30	4.00
GWP _(100a) *	---	1397	1397	1397	1397
CO ₂ equivalent	t	2.5	2.5	3.2	5.6

Table 5	Unit	IN 2050 PW	IN 2560 PW		
Refrigerant	---	R-449A	R-449A		
Maximum filling weight	kg	2.30	4.00		
GWP _(100a) *	---	1397	1397		
CO ₂ equivalent	t	3.2	5.6		

Integral XT with two-stage cooling unit

Table 6	Unit	IN 280 XT	IN 280 XTW	IN 590 XTW	IN 1590 XTW
Refrigerant first stage	---	R-449A	R-449A	R-449A	R-449A
Maximum filling weight first stage	kg	0.80	0.80	1.50	3.40
GWP _(100a) *	---	1397	1397	1397	1397
CO ₂ equivalent	t	1.1	1.1	2.1	4.7
Refrigerant second stage	---	R-23	R-23	R-508B	R-508B
Maximum filling weight second stage	kg	0.40	0.38	1.20	1.80
GWP _(100a) *	---	14800	14800	13400	13400
CO ₂ equivalent	t	5.9	5.6	16.1	24.1



Global Warming Potential (GWP), CO₂ comparison = 1.0
*Time frame 100 years - according to IPCC IV

15.5 Technical data of the high-temperature thermostats

Table 1	Unit	IN 4 XTW	IN 8 XTW
Working temperature range	°C	25 – 320	25 – 320
Temperature stability ②	K	±0.1	±0.1
Device dimensions width x depth x height	mm	430 x 550 x 760	430 x 550 x 760
Filling volume			
- minimum	L	3.3	3.6
- Maximum	L	9.5	9.8
Pump data 50/60 Hz			
- maximum discharge pressure	bar	3.1	3.1
- Maximum flow rate	l/min	60	60
Connecting thread (external) pump connector outflow/return flow	mm	M30 x 1.5	M30 x 1.5
Noise level 50 Hz ③	dB(A)	52	52
Noise level 60 Hz ③	dB(A)	52	52
Weight	kg	78	85
Distance of device from other objects			
- Front	mm	200	200
- Back	mm	200	200
- Right	mm	200	200
- Left	mm	200	200

② - Temperature stability determined according to standard DIN 12876-2

③ - Noise level determined according to standard EN 11201 for operating position in front of the device at 1 meter distance



The noise level of the various devices was measured according to the guidelines included in DIN EN ISO 11200 and the basic standards cited therein. The measured values correspond to the operating conditions that occur during typical device operation.

Cooling output

Table 2	Unit	IN 4 XTW	IN 8 XTW	Pump level
Cooling output at (ambient temperature 20 °C) 300 °C with thermal oil	kW	17	17	8

Table 2	Unit	IN 4 XTW	IN 8 XTW	Pump level
200 °C with thermal oil	kW	17	17	8
150 °C with thermal oil	kW	17	17	8
100 °C with thermal oil	kW	10	10	8
50 °C with thermal oil	kW	2	2	8
Cooling medium	---	Water	Water	---
Connecting thread of cooling water internal/external	Inches	G3/4"	G3/4"	---
Cooling water temperature minimum/maximum	°C	10/30	10/30	---
Recommended cooling water temperature	°C	15	15	---
Minimum differential pressure of cooling water	bar	3	3	---
Maximum cooling water pressure	bar	10	10	---
Maximum cooling water consumption	l/min	11	11	---

Heating output and power supply

If the maximum current consumption is limited  "Limiting the current consumption" on page 96 the heating output can be reduced.

Depending on the country-specific version, the maximum current consumption may already be limited ex works.

Table 3	Unit	IN 4 XTW
Heating output		
- 230 V; 50 Hz	kW	3.5
- 200 V; 50/60 Hz	kW	2.9
- 208-220 V; 60 Hz	kW	3.1 – 3.3
Current consumption	A	16
The mains plug for the United Kingdom (Great Britain) reduces the performance data.		
- 230 V; 50 Hz	kW	2.8
Current consumption	A	13

Table 4	Unit	IN 8 XTW
Heating output		
- 400 V; 3/PE~50 Hz & 460 V; 3/PE~60 Hz	kW	8.0
Current consumption	A	13.5

Subject to technical modifications!

15.6 Pump characteristics for Integral T

measured with water for IN 130 T,
IN 230 T, IN 230 TW

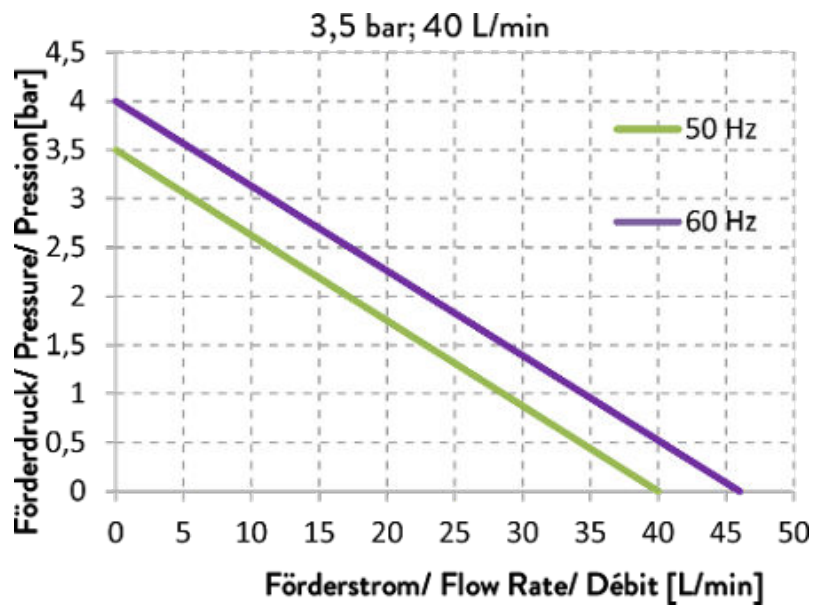

Fig. 92: IN 130 T, IN 230 T, IN 230 TW

measured with water for IN 530 T,
IN 530 TW

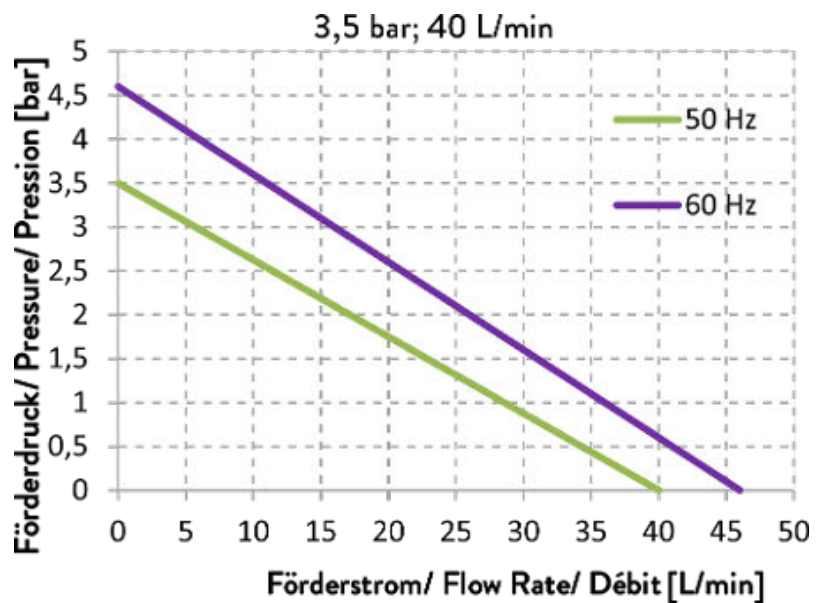

Fig. 93: IN 530 T, IN 530 TW

measured with water for IN 1030 T,
IN 1330 TW, IN 1830 TW

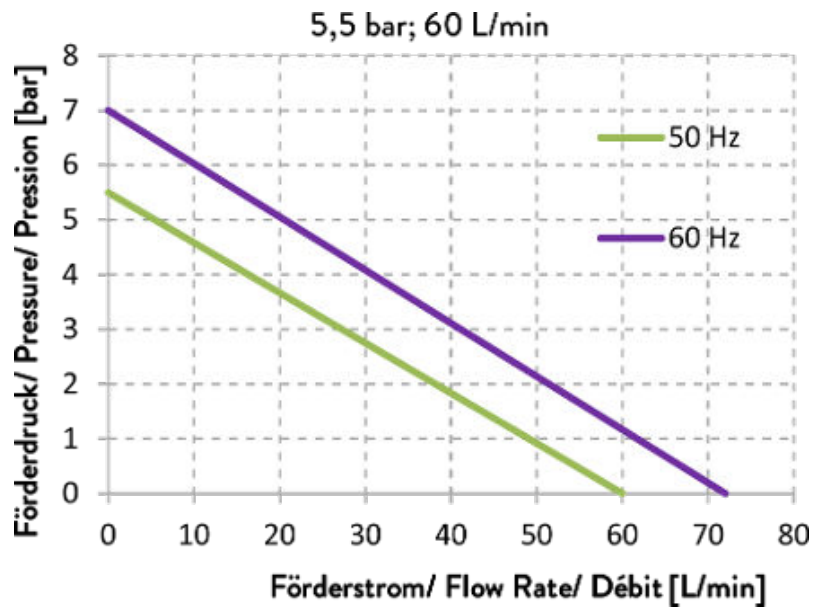

Fig. 94: IN 1030 T, IN 1330 TW, IN 1830 TW

15.7 Pump characteristics for Integral XT

Pump levels 1 - 8, measured with water



Fig. 95: all devices smaller than IN 1850 XT

Pump levels 1 - 8, measured with water



Fig. 96: IN 1850 XT, IN 2050 PW

Pump levels 4 - 8, measured with water

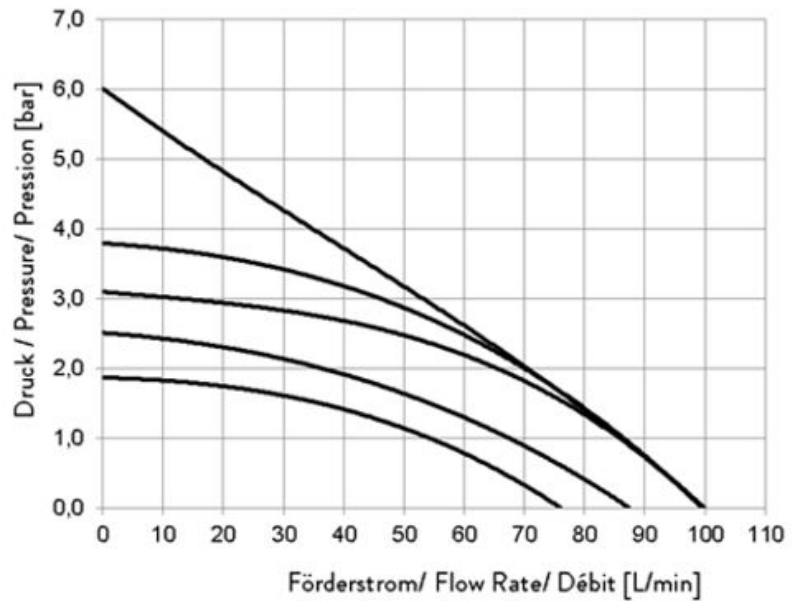

Fig. 97: IN 2560 XTW, IN 2560 PW

15.8 Pump characteristics for high-temperature thermostats

Pump levels 1 - 8, measured with water

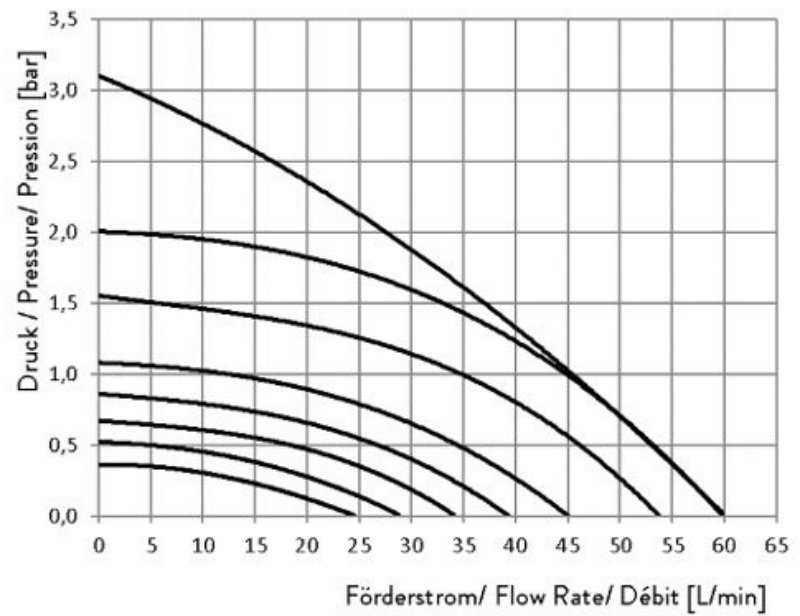

Fig. 98: IN 4 XTW, IN 8 XTW

15.9 Declaration of Conformity and certificates



EU DECLARATION OF CONFORMITY

Manufacturer: LAUDA DR. R. WOBSEY GMBH & CO. KG
Laudaplatz 1, 97922 Lauda-Königshofen Germany

We hereby declare under our sole responsibility that the machines described below

Product Line: Integral **Serial number:** from S210000001

Types: IN 4 XTW, IN 8 XTW

comply with all relevant provisions of the EC Directives listed below due to their design and type of construction in the version brought on the market by us:

Machinery Directive	2006/42/EC
EMC Directive	2014/30/EU
RoHS Directive	2011/65/EU In connection with (EU) 2015/863

The equipment is not covered by the Pressure Equipment Directive 2014/68/EU, as the maximum classification of the equipment is Category 1 and it is covered by the Machinery Directive.

The protective objectives of the Machinery Directive with regard to electrical safety are complied with in accordance with Annex I Paragraph 1.5.1 in conformity with the Low Voltage Directive 2014/35/EU.

Applied harmonized standards:

- EN ISO 12100:2010
- EN 61326-1:2013
- EN 61326-3-1:2017
- EN 61010-1:2010/A1:2019/AC:2019-04
- EN 61010-2-010:2014

Authorized representative for the composition of the technical documentation:

Dr. Jürgen Dirscherl, Head of Research & Development

Lauda-Königshofen, 05.11.2021



Dr. Alexander Dinger, Head of Quality Management



EC DECLARATION OF CONFORMITY

Manufacturer: LAUDA DR. R. WOBSE GMBH & CO. KG
Laudaplatz 1, 97922 Lauda-Königshofen Germany

We hereby declare under our sole responsibility that the machines described below

Product Line: Integral **Serial number:** from S190000001

Types: IN 130 T, IN 150 XT, IN 230 T, IN 230 TW, IN 250 XTW, IN 280 XT, IN 280 XTW, IN 530 T, IN 530 TW, IN 550 XT, IN 550 XTW, IN 590 XTW, IN 750 XT, IN 950 XTW, IN 1030 T, IN 1330 TW, IN 1590 XTW, IN 1830 TW, IN 1850 XTW, IN 2050 PW, IN 2560 XTW, IN 2560 PW

comply with all relevant provisions of the EC Directives listed below due to their design and type of construction in the version brought on the market by us:

Machinery Directive	2006/42/EC
EMC Directive	2014/30/EU
RoHS Directive	2011/65/EU In connection with (EU) 2015/863

The equipment is not covered by the Pressure Equipment Directive 2014/68/EU, as the maximum classification of the equipment is Category 1 and it is covered by the Machinery Directive.

The protective objectives of the Machinery Directive with regard to electrical safety are complied with in accordance with Annex I Paragraph 1.5.1 in conformity with the Low Voltage Directive 2014/35/EU.

Applied standards:

- EN ISO 12100:2010
- EN 61326-1:2013
- EN 61326-3-1:2017
- EN 378-2:2018
- EN 61010-1:2010/A1:2019/AC:2019-04
- EN 61010-2-010:2014

Authorized representative for the composition of the technical documentation:

Dr. Jürgen Dirscherl, Head of Research & Development

Lauda-Königshofen, 23.09.2021

Dr. Alexander Dinger, Head of Quality Management
Document number: Q5WA-QA13-011-EN Version 06

*FAHRENHEIT. *CELSIUS. *LAUDA.

The certificate is only valid for devices with cTUVus certification marks on the rating label.

ZERTIFIKAT ◆ CERTIFICATE ◆ 認證證書 ◆ CERTIFICADO ◆ CERTIFICAT



CERTIFICATE

No. U8 019054 0010 Rev. 00

Holder of Certificate: LAUDA
DR. R. WOBSE GMBH & CO. KG
Pfarrstraße 41/43
97922 Lauda-Königshofen
GERMANY

Certification Mark:



Product: Temperature controller
Process Temperature Controllers

This product was voluntarily tested to the relevant safety requirements referenced on this certificate. It can be marked with the certification mark above. The mark must not be altered in any way. This product certification system operated by TÜV SÜD America Inc. most closely resembles system 3 as defined in ISO/IEC 17067. Certification is based on the TÜV SÜD "Testing and Certification Regulations". TÜV SÜD America Inc. is an OSHA recognized NRTL and a Standards Council of Canada accredited Certification body.

Test report no.: 713191528

Date, 2020-12-01

(Benedikt Pulver)



America

CERTIFICATE

No. U8 019054 0010 Rev. 00

Model(s): Integral Process Thermostat IN xxyy T* NRTL
 Integral Process Thermostat IN xxyy TW* NRTL
 Integral Process Thermostat IN xxyy XT* NRTL
 Integral Process Thermostat IN xxyy XTW* NRTL
 where :
 xx: cooling capacity in kW at 20°C (one or two sign)
 yy: minimum temperature
 Option
 * FC - with flow control unit

Tested according to: UL 1995:2018
 CSA C22.2 no. 236-15 Ed. 5th

Production Facility(ies): 019054

Parameters:

Rated voltage: Single phase supply
 208-220V; 1Ph AC; PE; N; 60Hz
 for type : 130T; 230T; 230TW; 150XT and 250XTW
 3 Ph. Supply
 460V; 3Ph / PE; 60Hz
 for type: 530T; 1030T; 530TW; 1330TW; 1830TW; 280XT;
 280XTW; 550XT; 550XTW; 590XTW; 750XT; 950XTW;
 1590XTW; 1850XTW

Rated frequency: 60 Hz

Rated current: 16A for type
 130T; 230T; 230TW; 150XT; 250XTW; 530T; 1030T; 530TW;
 280XT; 280XTW; 550XT; 550XTW; 590XTW; 750XT; 950XTW
 25A for type
 1030T; 1330TW; 1830TW; 1590XTW; 1850XTW

Protection class: IP 21

15.10 Modular mimic displays

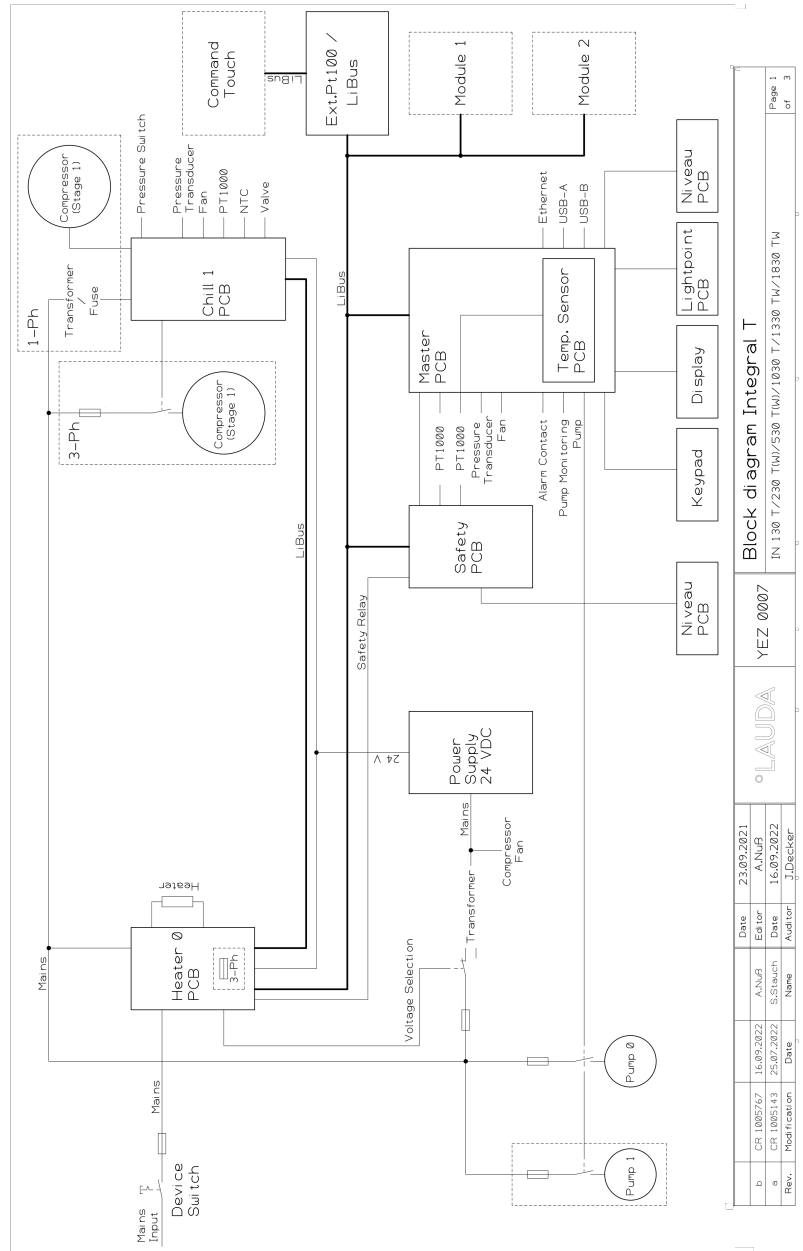
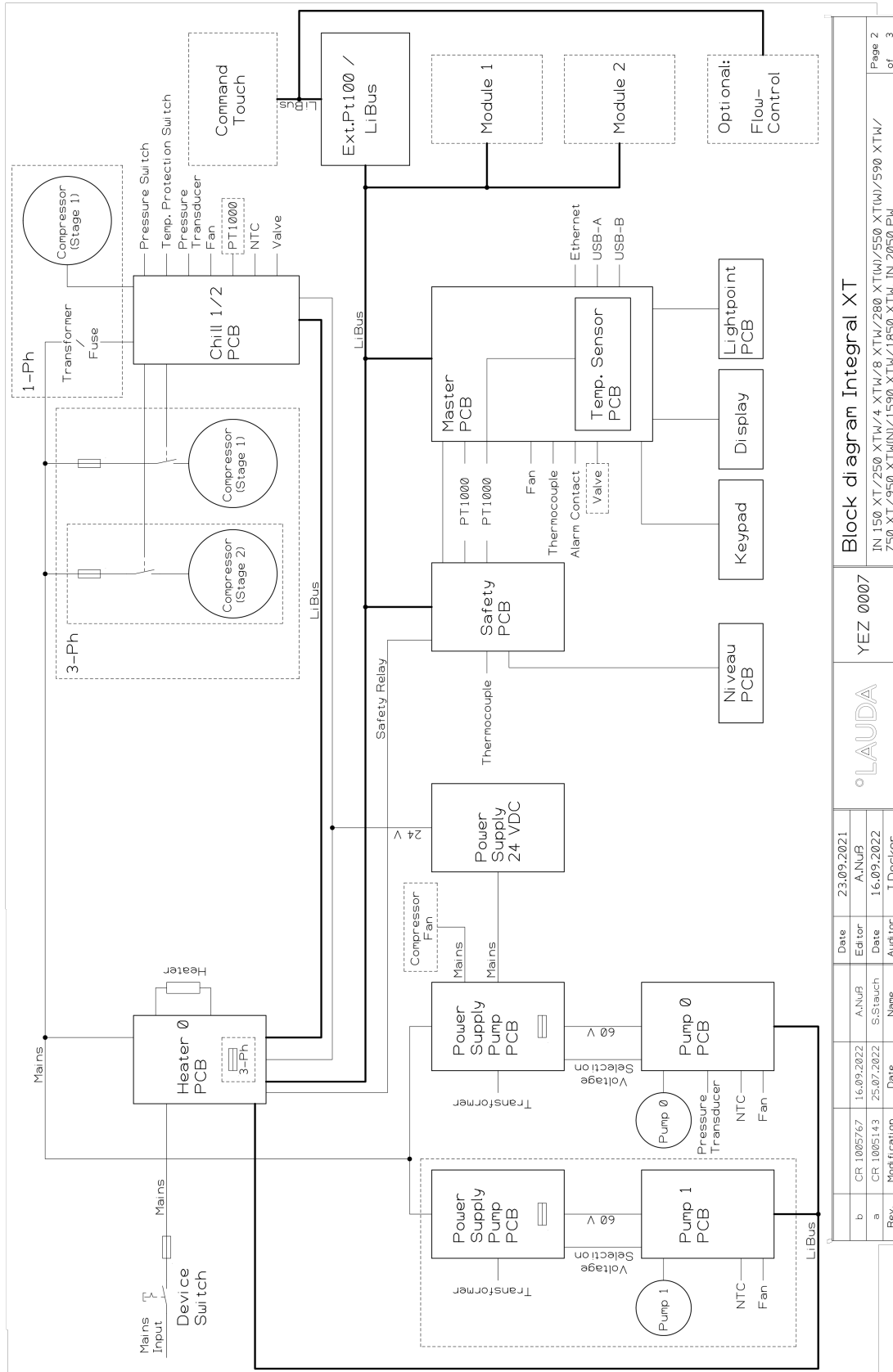

Fig. 99: Modular mimic display for Integral T



Rev.		Modification	Date	Name	Date		Editor	
b	CR 1005767		16.09.2022	A.NuB	23.09.2021	A.NuB		
a	CR 1005143		25.07.2022	S.Stauch	16.09.2022	A.NuB		
						J.Decker		

Block diagram Integral XT

IN 150 XT/250 XTW/4 XTW/8 XTW/280 XTW/550 XTW/590 XTW/
750 XT/950 XT(MN)/1590 XTW/1850 XTW. IN 2050 PM

°LAUDA

YEZ 0007

Fig. 100: Modular mimic display for Integral XT (without IN 2560 XTW/PW)

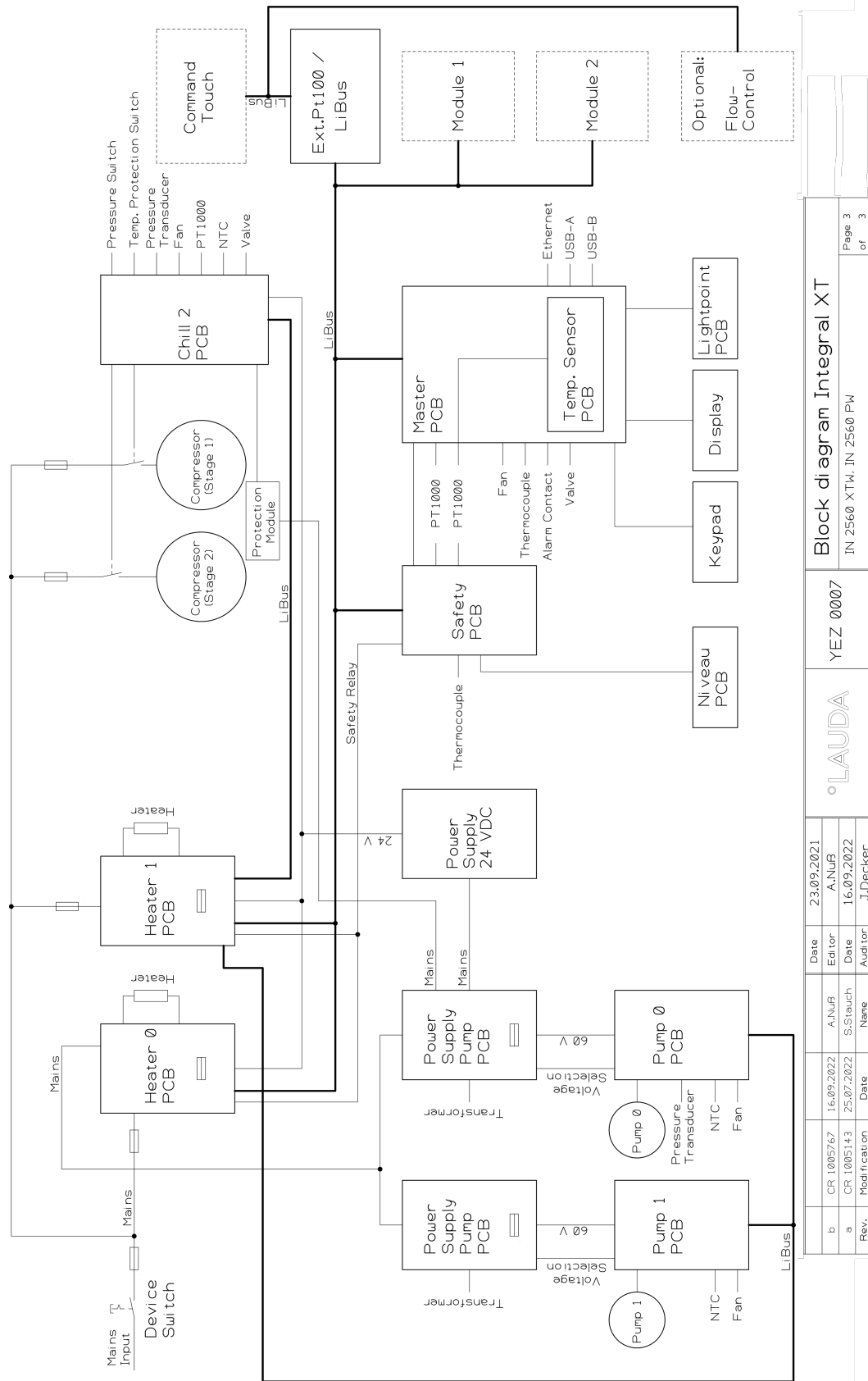

Rev.	Modification	Date	Name	Date	Auditor
a	CR 1005143	25.07.2022	S.Stauch	16.09.2022	J.Decker
b	CR 1005767	16.09.2022	A.Nuß	23.09.2021	

LAUDA		YEZ 0007	Block diagram Integral XT
		IN 2560 XTW, IN 2560 PW	Page 3 of 3

Fig. 101: Modular mimic display for Integral IN 2560 XTW/PW

15.11 Product Returns and Clearance Declaration

Product Returns

Would you like to return a LAUDA product you have purchased to LAUDA? For the return of goods, e.g. for repair or due to a complaint, you will need the approval of LAUDA in the form of a *Return Material Authorization (RMA)* or *processing number*. You can obtain the RMA number from our customer service department at +49 (0) 9343 503 350 or by email service@lauda.de.

Return address

LAUDA DR. R. WOBSEER GMBH & CO. KG

Laudaplatz 1

97922 Lauda-Königshofen

Deutschland/Germany

Clearly label your shipment with the RMA number. Please also enclose this fully completed declaration.

RMA number	Product serial number
Customer/operator	Contact name
Contact email	Contact telephone
Zip code	Place
Street & house number	
Additional explanations	

Clearance Declaration

The customer/operator hereby confirms that the product returned under the above-mentioned RMA number has been carefully emptied and cleaned, that any connections have been sealed to the farthest possible extent, and that there are no explosive, flammable, environmentally hazardous, biohazardous, toxic, radioactive or other hazardous substances in or on the product.

Place, date	Name in block letters	Signature

16 Index

A

Accessories	163
In series	17
Modules	163
Actual temperature (display)	66
Adaptation process	110
Adjusting the brightness (display)	95
Adjusting the display brightness	95
Adjusting the volume (sound)	94
Adjustment time	112, 114
Air-cooled	
Cleaning the condenser	146
Alarm	151
Codes	153
Description	151
Application	
connect	36
Attenuation time	112, 114
Autostart	
Activating	95
Deactivating	95

B

Bypass	
internal	79

C

Calibrate (actual temperature)	
Determine	97
Calibration in the factory	97
Certificate	
CA	124
Download	124
Change	
heat transfer liquid	159
changed	
Sounds	94
Checking	
Heat transfer liquid	150
Low-level protection	149

Overtemperature protection	148
Tmax	148
Cleaning	146
Cloud	126
CO2 equivalent	180
Code	
Alarms	153
Configure alarm output	45
Consumer	
connect	36
Contact	165
Control	
Defining the controller output limit	90
Control parameter	
Defining correction limitation	116
External (overview)	115
Control parameter set	119
Control parameters	
Changing	117
Internal (overview)	114
Control variable	
Activation	116
Cookies	125
Cooling	
Without reheating	92
Cooling unit	
Setting	92
single-stage	174, 179
two-stage	177, 181
Cooling water	
Connecting	44
Connection information	44
Pressure	44, 175
Requirements	42
Setting	44
Temperature	44, 175
Cooling water circuit	
Draining	148, 160
Copyright	164

Correction limitation	112, 115	Refrigerant	161
Corrugated metal hose	34	Disposing of refrigerant	161
Cracking	90	Draining	
D		Cooling water circuit	148, 160
Damping time	115	Device	157
Dead-time correction	91	drum pump	75
Defining the language (display)	96	E	
Defining the menu language	96	Emissions class	10
Degassing		Enter	
Automatic	76	Temperature	68
Compressed air	76	Entry window	
Inert gas	76	Entering a value	68
Mode	76	Selecting options	68
Descaling	148	Structure	68
Device		Error	151
Cleaning	146	Description	151
Cleaning condenser (air-cooled)	146	Read out memory	100
Decontamination	146	Error messages	61
Displaying serial numbers	102	Establishing a mains connection	62
Disposal (packaging)	161	Establishing a power supply	62
Disposal (refrigerant)	161	Ethernet	
Draining	157	Setting	46
Filling	73	External consuming unit	
Installation	33	connect	36
Read out memory	100	External control	
Structure	21, 22, 23, 24	Defining the setpoint offset	89
Switching on	65	F	
Unpacking	17	Factory calibration	97
Viewing data	101	Factory setting	
DIN EN 378-1	12	Cooling	92
Display	95	Restore	99, 100
Actual temperature	66	Fault	151
Home window (structure)	66	Filling	73
Soft key bar	66	Heat transfer liquid	143
Status bar (structure)	66	Flow controller	91
Temperatures	95	Fluid	71
Displaying serial numbers (device)	102	G	
Disposal		Gain factor	115
Ethanol	162	GNU	164
Liquid	162		
Packaging	161		

Graph	
Window (structure)	69
GWP	180
H	
Hardware version	102
heat transfer liquid	
Change	159
Heat transfer liquid	
Checking	150
Disposal	162
Removal	157
Safety data sheet	39
Heater	
Limitation	92
Heating output	
reduction	90
Hold-back time	112, 114
Home window	
START	66
STOP	66
Structure	66
Hose	34
HyperTerminal	49
I	
ID	124
Immunity	10
Improper use	11
Installation	
Device	33
Intended use	11
Interface	44
Interface functions	
Read commands	53
Write commands	58
IP	124
K	
Keep-alive	121
Kpe	115, 118
L	
LAUDA Service	165
LAUDA.LIVE	
Access	126
Cloud	126
Lead time	115
License texts	164
Light point	66
Limitation	
Heater	92
Limits (temperature)	
Setting	93
Liquid	
Disposal	162
Lock	
Buttons	93
Lock the entry functions	93
Lock the operating button	93
Low-level protection	
Checking	149
Definition	15
M	
Maintenance	
Intervals	145
Maximum temperature	148
MID	91
MIT	164
Modules	
Accessories	163
O	
Offset (actual temperature)	
Calibrate	97
Operator	121
OUT	
Contact	45
Overtemperature protection	
Definition	14
Overtemperature switch-off point	
Setting	89

P	
Packaging	
Disposal	161
Personal protective equipment (overview)	13
Personnel qualification (overview)	13
Power failure	95
Pressure control	79
pressure pump	75
Program	
Create	107
Edit	107
Example	103
Program optimization	
Description	103
Prop_E	115, 118
Proportional range	112, 114, 115
Protective equipment (personal, overview)	13
Pump	
Selecting the flow rate level	79
Selecting the level	79
Selecting the output level	79
Pump characteristic curve	184, 185
R	
Read commands	53
Read privileges	121
Reading out memory (error)	100
Refrigerant	
Filling charge	180
Filling weight	180
Fluorinated	12
Reset time	115
S	
Safe Mode	
Activated	128
Switch on	128
Safety data sheet	
Download	39
Heat transfer liquid	39
Safety notice	7
Segment	
Start	105
Segments	107
Serial numbers	28, 124
Service	165
Set time	110
Setting the current consumption	96
single-stage cooling unit	179
Softkey bar (display)	66
Software version	102
Sound (adjusting)	94
Start	
Segment	105
Status bar (display)	66
Structure	
Device	21, 22, 23, 24
Switching on	65
Symbol	
Cloud	126
T	
Td	112, 114
Tde	115, 118
Technical data	
Pump characteristic curve	184, 185
Temperature	
Enter	68
Temperature limits	
Setting	93
Terminal program	49
Three-phase motor	
Direction of rotation	62
Throttle	79
Tih, Til	93
Til, Tih	93
Time period	52
Time zone	110
Tmax	
Checking	148
Setting	89
TmaxTank	89
Tn	112, 114

Tne	115, 118
Tv	112, 114
Tve	115, 118
two-stage cooling unit	181
U	
Unpacking	17
USB	31
V	
Version (software)	102
Viewer	121
Viewing configuration data (device)	101
W	
Warning	151
Description	151
Warranty	164
Write commands	58
Write privileges	121
X	
Xp	112, 114
Xpf	115, 118
Y	
Year of construction	28

Manufacturer

LAUDA DR. R. WOBSE GMBH & CO. KG ° Laudaplatz 1 ° 97922 Lauda-Königshofen

Telephone: +49 (0)9343 503-0

E-mail: info@lauda.de ° Internet: <https://www.lauda.de>